



CATALOGO AMMORTIZZATORI ed ACCESSORI

SHOCK ABSORBERS and ACCESSORIES CATALOGUE

CATALOGUE AMORTISSEURS et ACCESSOIRES



ed.2

AMMORTIZZATORI AB-PARTS: I VOSTRI ALLEATI PER UNA GUIDA SICURA E CONFORTEVOLE

Gli ammortizzatori sono l'elemento chiave delle sospensioni di un'auto. Operano in sinergia con le componenti elastiche che li mantengono fissati al telaio della vettura: andando ad assorbirne in modo graduale e progressivo le oscillazioni evitano che la vettura, affrontando le irregolarità stradali, assuma un moto oscillatorio dannoso sia per il confort di marcia che per la tenuta di strada.

Compiono quindi un lavoro particolarmente gravoso, dovendo gestire nel corso della loro vita utile un numero elevatissimo di oscillazioni, sia lente - nel caso di avvallamenti stradali - che rapide - nel caso ad esempio di buche nell'asfalto o marcia su terreni sconnessi. Il tutto in ambienti con temperature estremamente variabili e alla mercè di agenti atmosferici, polvere e fango.

E' quindi indispensabile che nella loro progettazione vengano presi tutti gli accorgimenti necessari per far sì che possano svolgere appieno il loro lavoro in modo sicuro, confortevole e stabile per tutta l'arco di utilizzo previsto. Sono tutti fattori che sono stati ben tenuti in considerazione nella progettazione degli ammortizzatori **AB-PARTS**.

A livello di tecnologia di base, tutta la gamma prodotto è declinata in ammortizzatori **BITUBO a GAS**.

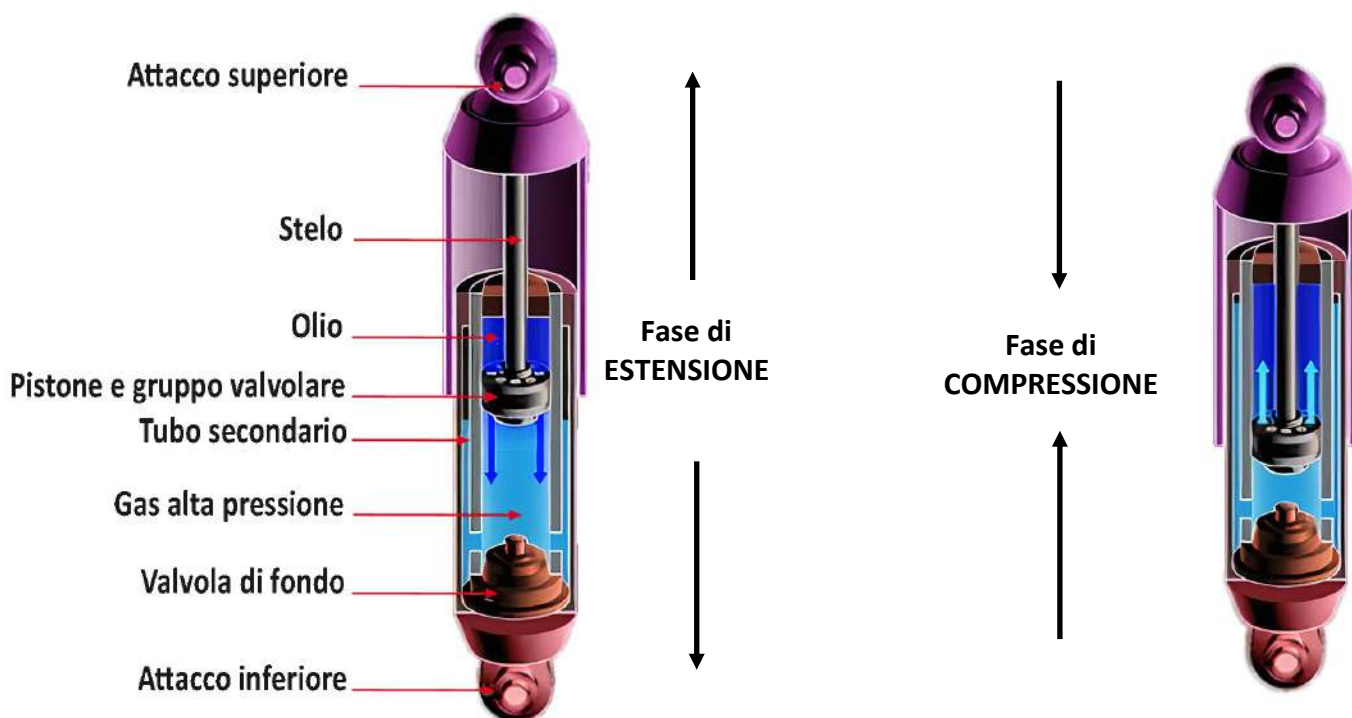

Sono molteplici i vantaggi che questa tipologia di prodotti possono garantire. Ma quali sono in sintesi le loro peculiarità?

Di base gli ammortizzatori per smorzare le sollecitazioni cui sono sottoposti basano il proprio funzionamento su un **pistone con gruppo valvolare**. Quando vengono raggiunti da una sollecitazione l'**olio** contenuto nel cilindro passa, in modo calibrato, da una parte all'altra del pistone, rallentando la corsa dello **stelo**.

Anche negli ammortizzatori a **GAS**, contrariamente a quanto si potrebbe pensare, la funzione di smorzamento viene principalmente svolta da un **olio** che è appositamente formulato per questo impiego e quindi particolarmente stabile in termini di viscosità e con elevato potere antischiuma. Gli spazi interni dove nelle vari fasi non viene a trovarsi olio risultano essere riempiti da un **gas** a base di Azoto che contribuisce in particolare al ridurre al minimo il rischio di emulsione dell'olio.

La struttura **BITUBO** prevede la presenza di due cilindri concentrici: in quello più interno scorre il pistone con gruppo valvolare mentre quello esterno detto **secondario** ha la funzione di contenere una parte del gas in misura variabile rispetto all'estensione dello stelo in quel dato momento. Questa struttura, relativamente complessa, garantisce diversi vantaggi rispetto ad un ammortizzatore a tubo singolo:

- *Maggior corsa a parità di ingombro complessivo dell'ammortizzatore;*
- *Superiore robustezza: il cilindro interno è protetto dall'intercapedine e può funzionare correttamente anche in caso di lievi ammaccature sul corpo esterno.*
- *Il gas contenuto è caricato a pressioni inferiori rispetto a quanto necessario in un ammortizzatore monotubo, consentendo una maggior durata e costanza di prestazioni.*

Esaminiamo nel dettaglio il funzionamento degli ammortizzatori **AB-PARTS**.

Fase di COMPRESIONE: partendo da una posizione estesa, l'**olio** viene a trovarsi nella parte inferiore dell'ammortizzatore. Applicando una compressione lo **stelo** viene spinto verso il basso e viene frenato dal **pistone con gruppo valvolare** in modo progressivo: a seconda della forza e velocità applicate l'**olio**, presente nella parte bassa fluisce attraverso le valvole calibrate verso la parte alta dissipando l'energia e trasformandola in calore. Mano a mano che l'olio si sposta nell'altra camera lo spazio vuoto viene immediatamente riempito dal **gas** precaricato nell'ammortizzatore e presente sia nel tubo principale che nel tubo **secondario**. Avvicinandosi alla posizione di fondo corsa o in caso di sollecitazione particolarmente intensa può entrare in funzione la **valvola di fondo** che permette se necessario l'afflusso di olio verso il tubo secondario (in cui normalmente è presente solo il gas).

Fase di ESTENSIONE: è speculare alla fase di compressione: qui l'olio si trova inizialmente nella parte superiore del **pistone con gruppo valvolare** e l'assorbimento della sollecitazione viene portato a termine dal passaggio di olio verso la parte bassa dell'ammortizzatore.

Nello sviluppo degli ammortizzatori AB-PARTS nessun dettaglio tecnico è stato trascurato.

I materiali

Sono stati selezionati metalli con le migliori caratteristiche tecniche in funzione della loro destinazione d'uso. L'impiego di questi metalli, abbinati a trattamenti termici - per una maggior durezza - ed a trattamenti galvanici - per conferire proprietà anticorrosione - garantisce affidabilità e resistenza durante tutta la vita del prodotto.

Lo **stelo** viene lavorato con lucidatrici longitudinali ad alta efficienza e, dopo una serie di passaggi intermedi, viene cromato deponendo uno strato di ben **20 micron**, quindi ben al di sopra degli standard usuali.

Scocca e rinforzi vengono assemblati in isole di **saldatura robotizzate**, garantendo un elevato controllo di tutti i parametri di questa delicata fase. Poiché per normale reazione durante la fase di saldatura viene a generarsi dell'idrogeno che, se assorbito dal metallo, può andarne a inficiare le caratteristiche, **AB-PARTS** sottopone poi tutte le parti ad un trattamento di **deidrogenazione**: viene così rimosso l'idrogeno dal metallo preservandone appieno durezza e resistenza.

Pistone e gruppo valvolare vengono realizzati con materiali idonei a durare nel tempo. Sono tra i componenti più stressati in quanto diretta interfaccia tra il movimento dello stelo ed il trasferimento della relativa forza sull'olio. Nella loro progettazione la delicata fase di taratura viene svolta non solo al banco ma anche con dei **test su strada su veicoli** permettendo di regolarli in modo ottimale garantendo confort e buon feedback di guida.

Paraolio e guarnizioni sono realizzati in materiali atti a sopportare pressioni e temperature ben al di sopra di quelli di funzionamento. Sono infatti in grado di operare a temperature comprese tra i -40° e 160° senza danneggiarsi, garantendo così una perfetta tenuta nel tempo.

Olio e gas

L'olio utilizzato, unitamente alle caratteristiche del pistone/gruppo valvolare, ha un effetto importantissimo sulle caratteristiche di funzionamento dell'ammortizzatore.

Tra le principali caratteristiche vanta:

- *Ottima capacità di carico a pressione*
- *Elevata protezione dall'usura delle componenti interne*
- *Ottima capacità di separazione dal gas*
- *Alta resistenza dall'invecchiamento*
- *Variabilità minima della viscosità al cambio della temperatura*
- *Proprietà antischiuma*
- *Range di lavoro da -40° a 100°*

La sua formulazione ne permette un comportamento in piena sinergia con il **gas** impiegato, a base di azoto, scongiurando la possibilità che si verifichi una emulsione dell'olio anche se sottoposto a condizioni gravose.

La verniciatura

AB-PARTS ha scelto per gli ammortizzatori di utilizzare la **verniciatura elettroforetica** in luogo della tradizionale verniciatura a polvere. Essa sfrutta il fenomeno della cataforesi: prevede l'immersione dei manufatti in un bagno composto da vernice diluita con acqua che, tramite il passaggio di corrente, riveste completamente la superficie delle parti immerse.

Questa tecnologia consente di applicare al prodotto uno strato di vernice dallo **spessore accuratamente controllato** e uniforme senza colature, sia su superfici piane che spigolose. Questo, unito alla presenza di un **legante chimico poliuretano**, conferisce alla verniciatura caratteristiche al contempo di flessibilità e resistenza garantendo una eccellente resistenza e protezione dagli agenti atmosferici.

Test durante il ciclo produttivo

Essendo prodotti piuttosto complessi sono stati predisposti diversi test di verifica qualità sia durante che al termine del ciclo produttivo. Tra i principali:

- **Stress test:** ciclicamente un campione di prodotto viene prelevato dalla linea e posto su un banco dinamometrico che lo sottopone a **12 milioni di attivazioni consecutive**, senza soste e con condizioni di carico superiori a quelle di lavoro. Al termine il prodotto deve presentare ancora comunque caratteristiche vicine a quelle del prodotto nuovo
- **Test tenuta paraoli:** a campione viene verificato che il prodotto, sottoposto a carichi estremi e posto in movimento, non manifesti danneggiamenti o deformazioni dei paraoli o trasudamenti dalle guarnizioni.
- **Test in nebbia salina:** a campione, sia le componenti verniciate che lo stelo vengono inseriti in camere con ambienti saliti estremamente corrosivi, per simulare in modo accelerato l'effetto degenerante degli agenti atmosferici cui gli ammortizzatori sono sottoposti con l'uso. Nei tempi previsti per le prove non devono manifestarsi fenomeni ossidativi.
- **Ispezione della forza di smorzamento:** a campione viene testata la capacità di smorzamento a 7 diverse velocità, verificando che la risposta sia in linea con quanto previsto in fase di progettazione.
- **Verifiche a fine linea:** **TUTTI** gli ammortizzatori prodotti vengono testati a due diverse velocità, controllando che rispettino le specifiche di progetto.



Gli ammortizzatori **AB-PARTS** sono tutti verniciati in nero opaco; codice prodotto e riferimento lotto sono incisi con tecnologia laser ed integrati da una etichetta che ricorda che **gli ammortizzatori AB-PARTS sono prodotti in stabilimenti che operano secondo normative IATF16949:2016**



All'interno della robusta confezione gli ammortizzatori sono inseriti in **busta pluriball** e protetti da **distanziali e protezioni in cartoncino** al fine di farli pervenire integri fino all'utilizzatore finale.

Completa il tutto un pieghevole con le **istruzioni di base per il montaggio**, in due lingue.



L'imballo riporta una etichetta con codice prodotto, principali applicazioni, quantità per scatola e posizione di montaggio, nonché il codice a barre.

Gli accessori

Per gli ammortizzatori inclusi in gamma sono forniti separatamente gli accessori di montaggio:

Supporti: costituiscono una delle principali interfacce dell'ammortizzatore con la vettura ed hanno il delicato compito, oltre al permetterne il mutuo scambio di forze, quello di consentire la corretta rotazione dell'ammortizzatore in fase di sterzata.

Soffietti parapolvere: vanno a riparare le parti più sollecitate dell'ammortizzatore da polvere e acqua che potrebbero ridurre drasticamente la durata nel tempo.

Tamponi fondo corsa: in caso di escursioni molto elevate vanno ad assorbirne l'energia residua andando ad evitare di danneggiare gli elementi interni dell'ammortizzatore.



La garanzia sul prodotto

Gli ammortizzatori AB-PARTS sono coperti da **garanzia di 2 anni**.

Tutti i dettagli di tale copertura sono consultabili sul sito www.ABPARTS.it.

AB-PARTS shock absorbers: your allies for a safe and comfortable driving



AB-PARTS shock absorbers are made with an high attention to materials and production processes. They are manufactured in plants operating according **IATF16949:2016** rules, so with the same standards that car manufacturers require to their parts suppliers.

Range include **twin tubes gas shock absorbers** only: this is the best technology currently available for standard use, granting good performances, a safe driving and a stable functioning over all their life time.

In summary:

Materials: only high quality steels are used, with employing of state of the art technologies during all phases. **Chrome applied on the stem is one of the most thick on the market, up to 20 micron.**

All seals are made with high quality rubbers that can work also over standard use conditions.

Welding: all parts are welded on an adequate and well prepared surface. All parts involved undergo a **dehydrogenation treatment** in order to eliminate hydrogen could be absorbed by metals during this phase, in order preserve their strenghtness.

Painting: all AB-PARTS shock absorbers are black matt painted by an **electrophoretic painting process.** It gives further advantaged if compared with a standard powder process, granting a layer of paint with constant thickness on all surfaces, even on edges and corners, and an high robustness thanks to a polyurethane chemical binder.

Process and final tests: **AB-PARTS** shock absorbers can count on severals sample tests during different phases to test efficacely each of them. Moreover, at the end, **the 100% of production is tested at two different speeds** in order to grant that only products in line with needed performances are packed.

Packing: a sturdy carton box is used for **AB-PARTS** shock absorbers. Moreover, internally they are placed in a pluriball bags and protected with carton supports and collars in order to preserve them up to the installer.



AB-PARTS also offer, for shock absorbers included in the range, all mounting accessories like strut mounts, dust covers and bumpers in order to permit a full maintenance to the suspension system.

AB-PARTS shock absorbers are covered with a 2-years warranty. Please refer to www.ABPARTS.it for all details.



Amortisseurs AB-PARTS: vos alliés pour une conduite sûre et confortable



Les amortisseurs AB-PARTS sont fabriqués avec une grande attention aux matériaux et aux processus de production.

Ils sont fabriqués dans des usines qu'ils suivent les directives **IATF16949:2016**, donc avec les mêmes normes que les constructeurs automobiles exigent de leurs fournisseurs de pièces.

La gamme comprend uniquement des amortisseurs à **gaz bitubes** : c'est la meilleure technologie actuellement disponible pour une utilisation standard, garantissant de bonnes performances, une conduite sûre et un fonctionnement stable sur toute leur durée de vie.

En résumé:

Matériaux : seuls des aciers de haute qualité sont utilisés, en utilisant des technologies de pointe pendant toutes les phases. **Le chrome appliqué sur la tige est l'un des plus épais du marché**, jusqu'à 20 microns. Tous les joints sont fabriqués avec des caoutchoucs de haute qualité qui peuvent également fonctionner dans des conditions d'utilisation bien plus que standard.

Soudage : toutes les pièces sont soudées sur une surface adéquate et bien préparée. Toutes les pièces concernées subissent un traitement de **déshydrogénation** afin d'éliminer l'hydrogène qui pourrait être absorbé par les métaux lors de cette phase, afin de préserver leur solidité.

Peinture : tous les amortisseurs AB-PARTS sont peints en noir mat par un procédé de **peinture électrophorétique**. Il donne encore plus d'avantages par rapport à un processus de poudre standard, garantissant une couche de peinture d'épaisseur constante sur toutes les surfaces, même sur les bords et les coins, et une grande robustesse grâce à un liant chimique polyuréthane.

Process et tests finaux : Les amortisseurs **AB-PARTS** peuvent compter sur plusieurs tests sur échantillons lors de différentes phases pour tester efficacement chacun d'entre eux. De plus, à la fin, **100% de la production est testée à deux vitesses différentes** afin de garantir que seuls les produits conformes aux performances requises soient emballés.

Emballage : une boîte en carton solide est utilisée pour les amortisseurs **AB-PARTS**. De plus, à l'intérieur, ils sont placés dans des enveloppes à bulles et protégés par des supports et des colliers en carton afin de les conserver jusqu'à l'installateur.



AB-PARTS propose également, pour les amortisseurs inclus dans la gamme, tous les **accessoires de montage** tels que soufflets, pare-chocs et butée afin de permettre un entretien complet du système de suspension.

Les amortisseurs AB-PARTS sont couverts par une **garantie de 2 ans**. Veuillez vous référer à www.ABPARTS.it pour tous les détails.

APPLICAZIONI AMMORTIZZATORI ed ACCESSORI

SHOCK ABSORBERS and ACCESSORIES APPLICATIONS

AFFECTATIONS AMORTISSEURS et ACCESSOIRES

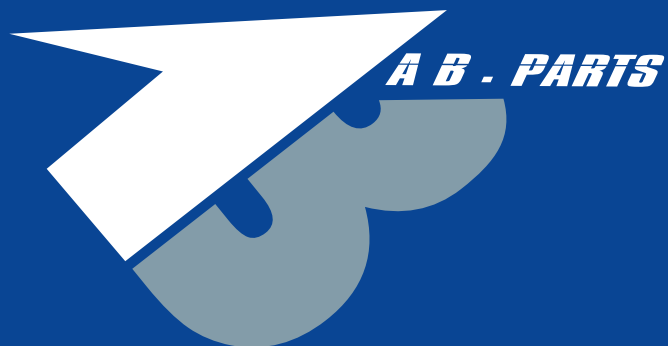

ALFA ROMEO		GIULIETTA (940_)			04.10 →	
	POSIZIONE	AMMORTIZZATORE	SUPPORTO	PARAPOLVERE	TAMPONE	
1.4 BiFuel, 1.4 TB, 1.6 JTDM, 1.8 TBi, 2.0 JTDM		ABA4056 (SX) ABA4057 (DX)	ABR5018 (SX) ABR5019 (DX)	ABS5602		
		ABA4055				
ALFA ROMEO		MITO (955)			09.08 →	
	POSIZIONE	AMMORTIZZATORE	SUPPORTO	PARAPOLVERE	TAMPONE	
0.9 , 1.3 JTDM, 1.4						
		ABA4004	ABR5003 (DX) ABR5020 (SX)	ABS5607		
AUDI		A2 (8Z0)			02.00 →	
	POSIZIONE	AMMORTIZZATORE	SUPPORTO	PARAPOLVERE	TAMPONE	
1.4, 1.4 TDI, 1.6 FSI		ABA4075				
		ABA4054				
AUDI		A3 (8P1)			05.03 →	
	POSIZIONE	AMMORTIZZATORE	SUPPORTO	PARAPOLVERE	TAMPONE	
1.2 TSI, 1.4 TFSI, 1.6, 1.6 E-Power, 1.6 FSI, 1.6 TDI, 1.8 TFSI, 1.9 TDI, 2.0 FSI, 2.0 TDI, 2.0 TDI 16V, 2.0 TFSI		ABA4000 ABA4011	ABR5000	ABS5606	ABT5308	
		ABA4001	ABR5001		ABT5309	
AUDI		A3 (8P1)			05.03 →	
	POSIZIONE	AMMORTIZZATORE	SUPPORTO	PARAPOLVERE	TAMPONE	
1.8 TFSI quattro, 2.0 TDI quattro, 2.0 TDI 16V quattro, 2.0 TDI quattro, 2.0 TFSI quattro, 3.2 V6 quattro		ABA4011	ABR5000	ABS5606	ABT5308	
		ABA4001	ABR5001		ABT5309	

AUDI		A3 Cabriolet (8P7)			04.08 →	05.13
		POSIZIONE	AMMORTIZZATORE	SUPPORTO	PARAPOLVERE	TAMPONE
1.2 TFSI, 1.4 TFSI, 1.6, 1.6 TDI, 1.8 TFSI, 1.9 TDI, 2.0 TDI, 2.0 TFSI		ABA4000 ABA4011	ABR5000	ABS5606	ABT5308	
		ABA4001	ABR5001		ABT5309	
AUDI		A3 Sportback (8PA)			09.04 →	
		POSIZIONE	AMMORTIZZATORE	SUPPORTO	PARAPOLVERE	TAMPONE
1.2 TFSI, 1.4 TFSI, 1.6, 1.6 E-Power, 1.6 FSI, 1.6 TDI, 1.8 TFSI, 1.9 TDI, 2.0, 2.0 FSI, 2.0 TDI, 2.0 TDI 16V, 2.0 TFSI		ABA4000 ABA4011	ABR5000	ABS5606	ABT5308	
		ABA4001	ABR5001		ABT5309	
AUDI		A3 Sportback (8PA)			09.04 →	
		POSIZIONE	AMMORTIZZATORE	SUPPORTO	PARAPOLVERE	TAMPONE
1.8 TFSI quattro, 2.0 TDI quattro, 2.0 TDI 16V quattro, 2.0 TDI quattro, 2.0 TFSI quattro, 3.2 V6 quattro		ABA4011	ABR5000	ABS5606	ABT5308	
		ABA4001	ABR5001		ABT5309	
AUDI		A1 (8X1, 8XF)			05.10 →	
		POSIZIONE	AMMORTIZZATORE	SUPPORTO	PARAPOLVERE	TAMPONE
1.2 TFSI, 1.4 TFSI, 1.6 TDI		ABA4039	ABR5011	ABS5604	ABT5300 ABT5302	
AUDI		A1 Sportback (8XA, 8XK)			09.11 →	
		POSIZIONE	AMMORTIZZATORE	SUPPORTO	PARAPOLVERE	TAMPONE
1.2 TFSI, 1.6 TDI		ABA4039	ABR5011	ABS5604	ABT5300 ABT5302	

AUTOBIANCHI	Y10			03.85 →	12.95
	POSIZIONE	AMMORTIZZATORE	SUPPORTO	PARAPOLVERE	TAMPONE
1.0, 1.0 Cat., 1.0 Turbo, 1.1, 1.1 i.e. Cat., 1.3 i.e. GT					
		ABA4023			
BMW	SERIE 1 Cabriolet (E88)			03.08 →	
	POSIZIONE	AMMORTIZZATORE	SUPPORTO	PARAPOLVERE	TAMPONE
118d, 118i, 120 d, 120 i, 120d, 120i, 123d, 125i, 135 i		ABA4050 (SX) ABA4051 (DX)	ABR5016	ABS5605	ABT5301
		ABA4049	ABR5015 + ABR5022		
BMW	SERIE 1 (E81)			09.04 →	09.12
	POSIZIONE	AMMORTIZZATORE	SUPPORTO	PARAPOLVERE	TAMPONE
116d, 116i, 118 i, 118d, 118i, 120d, 120i, 123d, 130i		ABA4050 (SX) ABA4051 (DX)	ABR5016	ABS5605	ABT5301
		ABA4049	ABR5015 + ABR5022		
BMW	SERIE 1 (E87)			11.03 →	09.12
	POSIZIONE	AMMORTIZZATORE	SUPPORTO	PARAPOLVERE	TAMPONE
116 d, 116 i, 118 d, 118 i, 120 d, 120 i, 123 d, 130 i		ABA4050 (SX) ABA4051 (DX)	ABR5016	ABS5605	ABT5301
		ABA4049	ABR5015 + ABR5022		
BMW	SERIE 1 Coupé (E82)			10.07 →	
	POSIZIONE	AMMORTIZZATORE	SUPPORTO	PARAPOLVERE	TAMPONE
118d, 120d, 120i, 123d, 125i, 135i		ABA4050 (SX) ABA4051 (DX)	ABR5016	ABS5605	ABT5301
		ABA4049	ABR5015 + ABR5022		

BMW		SERIE 3 (E90)			01.05 →	
	POSIZIONE	AMMORTIZZATORE	SUPPORTO	PARAPOLVERE	TAMPONE	
316d, 316i, 318d, 318i, 320 si, 320d, 320i, 323 i, 323i, 325d, 325i, 328 i, 330d, 330i, 335d, 335i						
		ABA4049	ABR5015 + ABR5022			
BMW		SERIE 3 Cabriolet (E93)			03.07 →	
	POSIZIONE	AMMORTIZZATORE	SUPPORTO	PARAPOLVERE	TAMPONE	
318i, 320d, 320i, 325d, 325i, 330d, 330i, 335i						
		ABA4049	ABR5015 + ABR5022			
BMW		SERIE 3 Coupé (E92)			09.06 →	
	POSIZIONE	AMMORTIZZATORE	SUPPORTO	PARAPOLVERE	TAMPONE	
316 i, 318i, 320 i, 320d, 320i, 325d, 325i, 330d, 330i, 335d, 335i						
		ABA4049	ABR5015 + ABR5022			
BMW		SERIE 3 Touring (E91)			09.05 →	
	POSIZIONE	AMMORTIZZATORE	SUPPORTO	PARAPOLVERE	TAMPONE	
316d, 316i, 318d, 318i, 320d, 320i, 323i, 325d, 325i, 330d, 330i, 335d, 335i						
		ABA4049	ABR5015 + ABR5022			
CHEVROLET		AVEO 2 volumi (T300)			03.11 →	
	POSIZIONE	AMMORTIZZATORE	SUPPORTO	PARAPOLVERE	TAMPONE	
1.2, 1.2 LPG, 1.3 D, 1.4						
		ABA4004				











CHEVROLET		AVEO Tre volumi (T300)			03.11 →	
	POSIZIONE	AMMORTIZZATORE	SUPPORTO	PARAPOLVERE	TAMPONE	
1.2, 1.3 D, 1.4						
		ABA4004				
CITROEN		C1 (PM_, PN_)			06.05 →	
	POSIZIONE	AMMORTIZZATORE	SUPPORTO	PARAPOLVERE	TAMPONE	
1.0, 1.4 HDi		ABA4012 ABA4013	ABR5007	ABS5612	ABT5310	
		ABA4014				
CITROEN		C3 Picasso			02.09 →	
	POSIZIONE	AMMORTIZZATORE	SUPPORTO	PARAPOLVERE	TAMPONE	
1.4, 1.4 VTi 95 LPG, 1.6, 1.6 HDi, 1.6 HDi 110, 1.6 HDi 115, 1.6 HDi 90		ABA4077 (DX) ABA4078 (SX)				
		ABA4024				
CITROEN		JUMPER			04.06 →	
	POSIZIONE	AMMORTIZZATORE	SUPPORTO	PARAPOLVERE	TAMPONE	
2.2 HDi, 3.0 Hdi Versione Heavy		ABA4063 D. 28mm				
		ABA4066 L.max 438				
CITROEN		JUMPER			04.06 →	
	POSIZIONE	AMMORTIZZATORE	SUPPORTO	PARAPOLVERE	TAMPONE	
2.2 HDi, 3.0 Hdi Versione Light		ABA4064 D. 25mm				
		ABA4065 L.max 465				

CITROEN		JUMPY			01.07 →	
	POSIZIONE	AMMORTIZZATORE	SUPPORTO	PARAPOLVERE	TAMPONE	
1.6, 1.6 HDi, 2.0 HDi		ABA4072 (DX) ABA4073 (SX)				
		ABA4074				
CITROEN		NEMO			02.08 →	06.12
	POSIZIONE	AMMORTIZZATORE	SUPPORTO	PARAPOLVERE	TAMPONE	
1.3 HDi, 1.3 BlueHDi, 1.4, 1.4 Hdi Tutte le versioni / All version		ABA4067 (DX) ABA4068 (SX)				
		ABA4069				
FIAT		500 (312)			10.07 →	
	POSIZIONE	AMMORTIZZATORE	SUPPORTO	PARAPOLVERE	TAMPONE	
0.9, 1.2, 1.2 LPG, 1.3 D Multijet, 1.4		ABA4016 (SX) ABA4017 (DX)	ABR5006	ABS5614		
		ABA4015				
FIAT		500C (312)			09.09 →	
	POSIZIONE	AMMORTIZZATORE	SUPPORTO	PARAPOLVERE	TAMPONE	
0.9, 1.2, 1.3 D Multijet, 1.4		ABA4016 (SX) ABA4017 (DX)	ABR5006	ABS5614		
		ABA4015				
FIAT		BRAVO II (198)			04.07 →	12.14
	POSIZIONE	AMMORTIZZATORE	SUPPORTO	PARAPOLVERE	TAMPONE	
1.4, 1.4 T-Jet, 1.4 LPG, 1.6 JTD, 1.9 JTD 8V, 1.9 JTD 16V, 2.0 JTD		ABA4070				
		ABA4071				

FIAT	CINQUECENTO (170)			07.91 →	01.98
	POSIZIONE	AMMORTIZZATORE	SUPPORTO	PARAPOLVERE	TAMPONE
0.7 (170AA), 0.7 i (170AD), 0.9 (170AB), 0.9 i.e. (170AC), 0.9 i.e. S (170AF, 170CF), 1.1 Sporting (170AH)					
		ABA4032			
FIAT	DOBLO (152, 263)			01.10 →	
	POSIZIONE	AMMORTIZZATORE	SUPPORTO	PARAPOLVERE	TAMPONE
1.4, 1.4 Natural Power, 1.3 JTD, 1.6 JTD, 2.0 JTD Tutti gli allestimenti / All version		ABA4058 (DX) ABA4059 (SX)			
		ABA4060			
FIAT	DUCATO			07.06 →	
	POSIZIONE	AMMORTIZZATORE	SUPPORTO	PARAPOLVERE	TAMPONE
2.0D, 2.2D, 2.3D, 3.0D incl. 4x4 Versione Heavy		ABA4063 D. 28mm			
		ABA4066 L.max 438			
FIAT	DUCATO			07.06 →	
	POSIZIONE	AMMORTIZZATORE	SUPPORTO	PARAPOLVERE	TAMPONE
2.0D, 2.2D, 2.3D, 3.0D incl. 4x4 Versione Light		ABA4064 D. 25mm			
		ABA4065 L.max 465			
FIAT	FIORINO (225)			11.07 →	
	POSIZIONE	AMMORTIZZATORE	SUPPORTO	PARAPOLVERE	TAMPONE
1.3D, 1.4, 1.4D		ABA4067 (DX) ABA4068 (SX)			
		ABA4069			

FIAT		GRANDE PUNTO (199)			10.05 →	
	POSIZIONE	AMMORTIZZATORE	SUPPORTO	PARAPOLVERE	TAMPONE	
1.2, 1.2 LPG, 1.3 D Multijet, 1.4, 1.4 16V, 1.4 Abarth, 1.4 LPG, 1.4 Natural Power, 1.4 T-Jet, 1.6 D Multijet, 1.9 D Multijet		ABA4018 (SX) ABA4019 (DX)	ABR5002	ABS5613	ABT5304	
		ABA4004	ABR5003 (DX) ABR5020 (SX)	ABS5607		
FIAT		IDEA (135)			12.03 →	
	POSIZIONE	AMMORTIZZATORE	SUPPORTO	PARAPOLVERE	TAMPONE	
1.2 16V, 1.4 8V, 1.4 16V, 1.4 LPG, 1.3 JTD, 1.6 JTD, 1.9 JTD		ABA4061				
		ABA4062				
FIAT		PANDA (141A_)			03.80 →	
	POSIZIONE	AMMORTIZZATORE	SUPPORTO	PARAPOLVERE	TAMPONE	
1000, 1000 i.e. Cat., 1100, 1300 D, 650, 750 (141AA), 750 (141AI), 750 (141AM) Cat., 900		ABA4022	ABR5008	ABS5601		
		ABA4023				
FIAT		PANDA (141A_)			03.80 →	
	POSIZIONE	AMMORTIZZATORE	SUPPORTO	PARAPOLVERE	TAMPONE	
800, 950		ABA4022	ABR5008	ABS5601		
						
FIAT		PANDA (169)			09.03 →	
	POSIZIONE	AMMORTIZZATORE	SUPPORTO	PARAPOLVERE	TAMPONE	
1.1, 1.2, 1.2 Bi-Power, 1.2 LPG, 1.3 D Multijet		ABA4020 (SX) ABA4021 (DX)	ABR5006	ABS5601		
		ABA4008				

FIAT		PANDA (169)			09.03 →	
1.2 4x4, 1.3 D 16V Multijet 4x4, 1.3 D Multijet 4x4, 1.4 Natural Power	POSIZIONE	AMMORTIZZATORE	SUPPORTO	PARAPOLVERE	TAMPONE	
		ABA4040 (DX) ABA4041 (SX)	ABR5006	ABS5609		
		ABA4033				
FIAT		PANDA Van (141_)			01.86 →	02.04
1.2 4x4	POSIZIONE	AMMORTIZZATORE	SUPPORTO	PARAPOLVERE	TAMPONE	
		ABA4040 (DX) ABA4041 (SX)	ABR5006	ABS5609		
		ABA4033				
FIAT		PANDA Van (141_)			01.86 →	02.04
1.2, 1.3 JTD	POSIZIONE	AMMORTIZZATORE	SUPPORTO	PARAPOLVERE	TAMPONE	
		ABA4020 (DX) ABA4021 (SX)	ABR5008	ABS5614		
		ABA4033				
FIAT		PANDA Van (169)			03.04 →	
1.2 4x4, 1.3 Multijet 4x4	POSIZIONE	AMMORTIZZATORE	SUPPORTO	PARAPOLVERE	TAMPONE	
		ABA4040 (DX) ABA4041 (SX)	ABR5006	ABS5609		
		ABA4033				
FIAT		PANDA Van (169)			03.04 →	
1.2 LPG	POSIZIONE	AMMORTIZZATORE	SUPPORTO	PARAPOLVERE	TAMPONE	
		ABA4020 (SX) ABA4021 (DX)	ABR5006	ABS5601		
		ABA4033				

FIAT	PUNTO (188)			09.99 →	
	POSIZIONE	AMMORTIZZATORE	SUPPORTO	PARAPOLVERE	TAMPONE
1.2 16V 80 (188.233, .235, .253, .255, .333, .353, .639, .63)		ABA4034			
		ABA4035			
FIAT	PUNTO (188)			09.99 →	
	POSIZIONE	AMMORTIZZATORE	SUPPORTO	PARAPOLVERE	TAMPONE
1.2 60 (188.030, .050, .130, .150, .230, .250), 1.2 Bifuel, 1.2 Natural Power, 1.3 JTD 16V, 1.4		ABA4034	ABR5006	ABS5603	
		ABA4035			
FIAT	PUNTO (188)			09.99 →	
	POSIZIONE	AMMORTIZZATORE	SUPPORTO	PARAPOLVERE	TAMPONE
1.8 130 HGT (188.738, .718)					
		ABA4035			
FIAT	PUNTO (188)			09.99 →	
	POSIZIONE	AMMORTIZZATORE	SUPPORTO	PARAPOLVERE	TAMPONE
1.9 DS 60 (188.031, .051, .231, .251), 1.9 JTD, 1.9 JTD 80 (188.237, .257, .337, .357)					
		ABA4035			
FIAT	PUNTO (199)			03.12 →	
	POSIZIONE	AMMORTIZZATORE	SUPPORTO	PARAPOLVERE	TAMPONE
0.9 Twinair Turbo, 1.2, 1.3 Multijet, 1.4, 1.4 Bifuel, 1.4 Multi Air, 1.4 Natural Power, 1.4 Turbo Multi Air		ABA4018 (SX) ABA4019 (DX)	ABR5002	ABS5613	ABT5304
		ABA4004	ABR5003 (DX) ABR5020 (SX)	ABS5607	

FIAT		PUNTO EVO (199)			07.08 →	
	POSIZIONE	AMMORTIZZATORE	SUPPORTO	PARAPOLVERE	TAMPONE	
1.2, 1.3 16V Multijet, 1.3 D Multijet, 1.4, 1.4 16V, 1.4 LPG, 1.4 Natural Power, 1.6 D Multijet		ABA4018 (SX) ABA4019 (DX)	ABR5002	ABS5613	ABT5304	
		ABA4004	ABR5003 (DX) ABR5020 (SX)	ABS5607		
FIAT		PUNTO EVO Van			03.09 →	
	POSIZIONE	AMMORTIZZATORE	SUPPORTO	PARAPOLVERE	TAMPONE	
1.3 D Multijet		ABA4018 (SX) ABA4019 (DX)	ABR5002	ABS5613	ABT5304	
		ABA4004	ABR5003 (DX) ABR5020 (SX)	ABS5607		
FIAT		PUNTO Van (188AX)			02.00 →	
	POSIZIONE	AMMORTIZZATORE	SUPPORTO	PARAPOLVERE	TAMPONE	
1.2 60, 1.3 JTD		ABA4034				
		ABA4035				
FIAT		PUNTO Van (188AX)			02.00 →	
	POSIZIONE	AMMORTIZZATORE	SUPPORTO	PARAPOLVERE	TAMPONE	
1.9 D 60, 1.9 JTD						
		ABA4035				
FIAT		PUNTO Van (199)			04.08 →	
	POSIZIONE	AMMORTIZZATORE	SUPPORTO	PARAPOLVERE	TAMPONE	
1.3 D Multijet, 1.4, 1.4 LPG, 1.4 Natural Power		ABA4018 (SX) ABA4019 (DX)	ABR5002	ABS5613	ABT5304	
		ABA4004	ABR5003 (DX) ABR5020 (SX)	ABS5607		

FIAT		QUBO (225)			09.08 →	
	POSIZIONE	AMMORTIZZATORE	SUPPORTO	PARAPOLVERE	TAMPONE	
1.3D, 1.4, 1.4D		ABA4067 (DX) ABA4068 (SX)				
		ABA4069				
FIAT		SCUDO (270)			01.07 →	
	POSIZIONE	AMMORTIZZATORE	SUPPORTO	PARAPOLVERE	TAMPONE	
1.6D, 2.0D		ABA4072 (DX) ABA4073 (SX)				
		ABA4074				
FIAT		SEICENTO (187)			01.98 →	
	POSIZIONE	AMMORTIZZATORE	SUPPORTO	PARAPOLVERE	TAMPONE	
0.9 (187AXA, 187AXA1A), 1.1 (187AXB, 187AXB1A)		ABA4036		ABS5610	ABT5303	
		ABA4032				
FIAT		SEICENTO Van (187)			01.98 →	
	POSIZIONE	AMMORTIZZATORE	SUPPORTO	PARAPOLVERE	TAMPONE	
0.9 (187AXA), 1.1 (187CXB/C)		ABA4036		ABS5610	ABT5303	
		ABA4032				
FIAT		STILO (192)			09.01 →	08.08
	POSIZIONE	AMMORTIZZATORE	SUPPORTO	PARAPOLVERE	TAMPONE	
1.2 16V, 1.4 16V, 1.6 16V, 1.8 16V, 1.9 JTD						
		ABA4071				











FORD		B-MAX (JK)			10.12 →	
		POSIZIONE	AMMORTIZZATORE	SUPPORTO	PARAPOLVERE	TAMPONE
1.0 EcoBoost, 1.4, 1.4 LPG, 1.5 TDCi, 1.6 TDCi, 1.6 Ti						
			ABA4005	ABR5004	ABS5617	ABT5317
FORD		B-MAX Van (JK)			10.12 →	
		POSIZIONE	AMMORTIZZATORE	SUPPORTO	PARAPOLVERE	TAMPONE
1.0 EcoBoost, 1.4, 1.4 LPG, 1.5 TDCi, 1.6 TDCi, 1.6 Ti						
			ABA4005	ABR5004	ABS5617	ABT5317
FORD		FIESTA VI (CB1, CCN)			06.08 →	04.17
		POSIZIONE	AMMORTIZZATORE	SUPPORTO	PARAPOLVERE	TAMPONE
1.25, 1.4, 1.4 LPG, 1.6 Ti, 1.4 TDCi, 1.6 TDCi			ABA4025 (DX) ABA4026 (SX)	ABR5005	ABS5615	ABT5316
			ABA4005	ABR5004	ABS5617	ABT5317
FORD		FIESTA VI (CB1, CCN)			06.08 →	04.17
		POSIZIONE	AMMORTIZZATORE	SUPPORTO	PARAPOLVERE	TAMPONE
1.0, 1.0 EcoBoost, 1.0 Sport, 1.4 LPG, 1.5 TDCi, 1.6, 1.6 Ti			ABA4006 (DX) AM4007 (SX)	ABR5005	ABS5615	ABT5316
			ABA4005	ABR5004	ABS5617	ABT5317
FORD		FIESTA VI Van			08.08 →	
		POSIZIONE	AMMORTIZZATORE	SUPPORTO	PARAPOLVERE	TAMPONE
1.0 EcoBoost, 1.5 TDCi			ABA4006 (DX) AM4007 (SX)	ABR5005	ABS5615	ABT5316
			ABA4005	ABR5004	ABS5617	ABT5317

FORD		TOURNEO COURIER (B460)			02.14 →	
		POSIZIONE	AMMORTIZZATORE	SUPPORTO	PARAPOLVERE	TAMPONE
1.0 EcoBoost, 1.5 EcoBlue, 1.5 TDCi, 1.6 TDCi						
			ABA4005	ABR5004	ABS5617	ABT5317
LANCIA		DELTA III (844)			01.09 →	12.14
		POSIZIONE	AMMORTIZZATORE	SUPPORTO	PARAPOLVERE	TAMPONE
1.4 T-Jet 16 V, 1.6 D, 1.8 Di T-Jet 16 V, 1.9 D, 2.0 D						
			ABA4071			
LANCIA		MUSA (350)			07.04 →	
		POSIZIONE	AMMORTIZZATORE	SUPPORTO	PARAPOLVERE	TAMPONE
1.4, 1.4 LPG, 1.3 JTD, 1.6 JTD, 1.9 JTD			ABA4061			
			ABA4062			
LANCIA		Y10 (156)			03.85 →	12.95
		POSIZIONE	AMMORTIZZATORE	SUPPORTO	PARAPOLVERE	TAMPONE
1.0 Fire, 1.0 Fire (156AA), 1.0 Fire (156AE) Cat., 1.0 Fire (156B, 156AD), 1.0 Fire (156C), 1.0 Turbo (156D), 1.1 i.e (156AC), 1.1 i.e. Fire (156AG), 1.3 i.e. Fire (156AB), 1.3 i.e. Fire (156AF)						
			AM3023			
LANCIA		YPSILON (843)			10.03 →	12.11
		POSIZIONE	AMMORTIZZATORE	SUPPORTO	PARAPOLVERE	TAMPONE
1.2, 1.3 D Multijet, 1.3 JTD, 1.4, 1.4 16V, 1.4 LPG			ABA4061			
			ABA4035			

MERCEDES BENZ		CLASSE A (W169)			09.04 →	06.12
		POSIZIONE	AMMORTIZZATORE	SUPPORTO	PARAPOLVERE	TAMPONE
A 150, A 160, A 160 CDI, A 170, A 180, A 180 CDI, A 200, A 200 CDI, A 200 CDI, A 200 TURBO			ABA4043	ABR5012	ABS5608	
			ABA4037			
MERCEDES BENZ		CLASSE B (W245)			03.05 →	11.11
		POSIZIONE	AMMORTIZZATORE	SUPPORTO	PARAPOLVERE	TAMPONE
B 150, B 160, B 170, B 170 NGT, B 180, B 180 CDI, B 180 NGT, B 200, B 200 CDI, B 200 CDI, B 200 TURBO			ABA4076			
			ABA4037			
OPEL		CORSA D			07.06 →	
		POSIZIONE	AMMORTIZZATORE	SUPPORTO	PARAPOLVERE	TAMPONE
1.0, 1.2, 1.2 ecoFLEX, 1.2 LPG, 1.4, 1.4 ecoFLEX, 1.4 LPG			ABA4002 (DX) ABA4003 (SX)	ABR5002	ABS5613	ABT5304
			ABA4004	ABR5003 (DX) ABR5020 (SX)	ABS5607	
OPEL		CORSA D			07.06 →	
		POSIZIONE	AMMORTIZZATORE	SUPPORTO	PARAPOLVERE	TAMPONE
1.3 CDTI, 1.7 CDTI			ABA4052 (DX) ABA4053 (SX)	ABR5002	ABS5613	ABT5304
			ABA4004	ABR5003 (DX) ABR5020 (SX)	ABS5607	
OPEL		CORSA D			07.06 →	
		POSIZIONE	AMMORTIZZATORE	SUPPORTO	PARAPOLVERE	TAMPONE
1.6 Turbo			ABA4002 (DX) ABA4003 (SX)	ABR5002	ABS5613	ABT5304
						

OPEL		CORSA D Van			07.06 →	
		POSIZIONE	AMMORTIZZATORE	SUPPORTO	PARAPOLVERE	TAMPONE
1.0, 1.2		ABA4002 (DX) ABA4003 (SX)	ABR5002	ABS5613	ABT5304	
		ABA4004	ABR5003 (DX) ABR5020 (SX)	ABS5607		
OPEL		CORSA D Van			07.06 →	
		POSIZIONE	AMMORTIZZATORE	SUPPORTO	PARAPOLVERE	TAMPONE
1.3 CDTI		ABA4052 (DX) ABA4053 (SX)	ABR5002	ABS5613	ABT5304	
		ABA4004	ABR5003 (DX) ABR5020 (SX)	ABS5607		
OPEL		COMBO TOUR (X12)			02.12 →	
		POSIZIONE	AMMORTIZZATORE	SUPPORTO	PARAPOLVERE	TAMPONE
1.4, 1.4 GPL, 1.3 CDTi, 1.6 CDTi, 2.0 CDTi		ABA4058 (DX) ABA4059 (SX)				
		ABA4060				
OPEL		COMBO CARGO (X12)			02.12 →	
		POSIZIONE	AMMORTIZZATORE	SUPPORTO	PARAPOLVERE	TAMPONE
1.4, 1.4 GPL, 1.3 CDTi, 1.6 CDTi, 2.0 CDTi Portata utile 750 Kg, 900 Kg e 1000 Kg		ABA4058 (DX) ABA4059 (SX)				
		ABA4060				
PEUGEOT		107			06.05 →	
		POSIZIONE	AMMORTIZZATORE	SUPPORTO	PARAPOLVERE	TAMPONE
1.0, 1.4 HDi		ABA4012 (SX) ABA4013 (DX)	ABR5007	ABS5612	ABT5310	
		ABA4014				

PEUGEOT		207 CC (WD_)			02.07 →	01.15
		POSIZIONE	AMMORTIZZATORE	SUPPORTO	PARAPOLVERE	TAMPONE
1.6 16V, 1.6 HDI			ABA4077 (DX) ABA4078 (SX)			
			ABA4024			
PEUGEOT		207 SW (WK_)			02.07 →	12.13
		POSIZIONE	AMMORTIZZATORE	SUPPORTO	PARAPOLVERE	TAMPONE
1.6 16V, 1.6 HDI			ABA4077 (DX) ABA4078 (SX)			
			ABA4024			
PEUGEOT		207/ 207+ (WA_, WC_)			02.06 →	12.15
		POSIZIONE	AMMORTIZZATORE	SUPPORTO	PARAPOLVERE	TAMPONE
1.,4 HDI, 1.6 16V, 1.6 HDI			ABA4077 (DX) ABA4078 (SX)			
			ABA4024			
PEUGEOT		208 I (CA_, CC_)			03.12 →	
		POSIZIONE	AMMORTIZZATORE	SUPPORTO	PARAPOLVERE	TAMPONE
1.0, 1.2 GPL, 1.2 PureTech 82 (CA_, CC_), 1.2 THP 110, 1.2 VTi 68 / PureTech 68, 1.2 VTi 82, 1.4 GPL, 1.4 Vti, 1.6 (kW : 88, 89, 115), 1.6 GTi, 1.6 THP 165, 1.4 HDi, 1.5 BlueHDi 100, 1.6 Hdi, 1.6 HDi / BlueHDi 75, 1.6 BlueHDi 100, 1.6 BlueH- Di 120			ABA4027 (DX) ABA4028 (SX)	ABR5009	ABS5611	ABT5315
			ABA4029 (DX) ABA4030 (SX)			
			ABA4024			
PEUGEOT		BIPPER			02.08 →	06.12
		POSIZIONE	AMMORTIZZATORE	SUPPORTO	PARAPOLVERE	TAMPONE
1.3 HDi, 1.3 BlueHDi, 1.4, 1.4 Hdi Tutte le versioni / All version			ABA4067 (DX) ABA4068 (SX)			
			ABA4069			

PEUGEOT	BOXER			04.06 →	
	POSIZIONE	AMMORTIZZATORE	SUPPORTO	PARAPOLVERE	TAMPONE
2.2 HDi, 3.0 Hdi Versione Heavy		ABA4063 D. 28mm			
		ABA4066 L.max 438			
PEUGEOT	BOXER			04.06 →	
	POSIZIONE	AMMORTIZZATORE	SUPPORTO	PARAPOLVERE	TAMPONE
2.2 HDi, 3.0 Hdi Versione Light		ABA4064 D. 25mm			
		ABA4065 L.max 465			
PEUGEOT	EXPERT			06.07 →	
	POSIZIONE	AMMORTIZZATORE	SUPPORTO	PARAPOLVERE	TAMPONE
1.6 HDi, 2.0 HDi, 2.0 16V		ABA4072 (DX) ABA4073 (SX)			
		ABA4074			
RENAULT	CLIO Grandtour (KR0/1_)			02.08 →	
	POSIZIONE	AMMORTIZZATORE	SUPPORTO	PARAPOLVERE	TAMPONE
1.2 16V, 1.2 16V (KR0P), 1.4 16V, 1.5 dCi, 1.5 dCi (KR0F), 1.5 dCi (KR0G), 1.5 dCi (KR0H), 1.5 dCi (KR1C, KR1N), 1.6 16V, 1.6 16V (KR0B)		ABA4038	ABR5010 (DX) ABR5021 (SX)	ABS5616	ABT5314
					
RENAULT	CLIO III (BR0/1, CR0/1)			01.05 →	
	POSIZIONE	AMMORTIZZATORE	SUPPORTO	PARAPOLVERE	TAMPONE
1.2 16V, 1.2 16V Hi-Flex, 1.2 16V (C/ BR1J, C/BR1Q), 1.4 16V, 1.5 D, 1.5 dCi, 1.5 dCi (C/BR1G), 1.6 16V, 1.6 16V GT, 2.0 16V		ABA4038	ABR5010 (DX) ABR5021 (SX)	ABS5616	ABT5314
		ABA4042			

RENAULT		CLIO III (BR0/1, CR0/1)			01.05 →	
	POSIZIONE	AMMORTIZZATORE	SUPPORTO	PARAPOLVERE	TAMPONE	
1.6 Hi-Flex		ABA4038	ABR5010 (DX) ABR5021 (SX)	ABS5616	ABT5314	
		ABA4042				
SEAT		ALHAMBRA (710)			06.10 →	
	POSIZIONE	AMMORTIZZATORE	SUPPORTO	PARAPOLVERE	TAMPONE	
1.4 TSI, 2.0 TDI, 2.0 TDI 4 ruote motrici, 2.0 TSI		ABA4011	ABR5000	ABS5606	ABT5308	
		ABA4001	ABR5001		ABT5312	
SEAT		ALTEA (5P1)			03.04 →	
	POSIZIONE	AMMORTIZZATORE	SUPPORTO	PARAPOLVERE	TAMPONE	
1.2 TSI, 1.4 16V, 1.4 TSI, 1.6, 1.6 LPG, 1.6 TDI, 1.8 TFSI, 1.9 TDI, 2.0 FSI, 2.0 TDI, 2.0 TDI 16V, 2.0 TFSI		ABA4000 ABA4011	ABR5000	ABS5606	ABT5308	
		ABA4001	ABR5001		ABT5313	
SEAT		ALTEA XL (5P5, 5P8)			10.06 →	
	POSIZIONE	AMMORTIZZATORE	SUPPORTO	PARAPOLVERE	TAMPONE	
1.2 TSI, 1.4 16V, 1.4 TSI, 1.6, 1.6 LPG, 1.6 Multifuel, 1.6 TDI, 1.8 TFSI, 1.9 TDI, 2.0 FSI, 2.0 TDI, 2.0 TDI 4x4, 2.0 TDI 16V, 2.0 TDI 4x4, 2.0 TFSI 4x4		ABA4000 ABA4011	ABR5000	ABS5606	ABT5308	
		ABA4001	ABR5001		ABT5313	
SEAT		CORDOBA (6L2)			09.02 →	
	POSIZIONE	AMMORTIZZATORE	SUPPORTO	PARAPOLVERE	TAMPONE	
1.2, 1.2 12V, 1.4 16V, 1.4 TDI, 1.6 16V, 1.9 SDI, 1.9 TDI, 2.0		ABA4075				
		ABA4054	ABR5017		ABT5307	

SEAT	IBIZA III (6L1)			02.02 →	11.09
	POSIZIONE	AMMORTIZZATORE	SUPPORTO	PARAPOLVERE	TAMPONE
1.2, 1.2 12V, 1.4 16V, 1.4 TDI, 1.6, 1.6 16V, 1.8 T FR, 1.9 SDI, 1.9 TDI, 2.0		ABA4075			
		ABA4054	ABR5017		ABT5307
SEAT	IBIZA IV (6J5, 6P5)			03.08 →	
	POSIZIONE	AMMORTIZZATORE	SUPPORTO	PARAPOLVERE	TAMPONE
1.2, 1.2 TDI, 1.2 TSI, 1.4, 1.4 TDI, 1.4 TSI, 1.6, 1.6 LPG, 1.6 TDI, 1.9 TDI, 2.0 TDI		ABA4039	ABR5011	ABS5604	ABT5300 ABT5302
		ABA4054	ABR5017		ABT5307
SEAT	IBIZA IV SPORTCOUPE (6J1, 6P1)			07.08 →	
	POSIZIONE	AMMORTIZZATORE	SUPPORTO	PARAPOLVERE	TAMPONE
1.2, 1.2 TDI, 1.2 TSI, 1.4, 1.4 TDI, 1.4 TSI, 1.6, 1.6 LPG, 1.6 TDI, 1.9 TDI		ABA4039	ABR5011	ABS5604	ABT5300 ABT5302
		ABA4054	ABR5017		ABT5307
SEAT	IBIZA IV ST (6J8, 6P8)			03.10 →	
	POSIZIONE	AMMORTIZZATORE	SUPPORTO	PARAPOLVERE	TAMPONE
1.2, 1.2 TDI, 1.2 TSI, 1.4, 1.4 TSI, 1.6, 1.6 TDI		ABA4039	ABR5011	ABS5604	ABT5300 ABT5302
		ABA4054	ABR5017		ABT5307
SEAT	LEON (1P1)			09.05 →	
	POSIZIONE	AMMORTIZZATORE	SUPPORTO	PARAPOLVERE	TAMPONE
1.2 TSI, 1.4 16V, 1.4 TSI, 1.6 LPG, 1.6 MultiFuel, 1.6 TDI, 1.8 TSI		ABA4000 ABA4011	ABR5000	ABS5606	ABT5308
		ABA4001	ABR5001		ABT5312

SEAT		LEON (1P1)			09.05 →	
1.6, 1.9 TDI	POSIZIONE	AMMORTIZZATORE	SUPPORTO	PARAPOLVERE	TAMPONE	
		ABA4000	ABR5000	ABS5606	ABT5308	
		ABA4001	ABR5001		ABT5312	

SEAT		LEON (1P1)			09.05 →	
2.0 FSI, 2.0 TDI, 2.0 TDI 16V, 2.0 TFSI	POSIZIONE	AMMORTIZZATORE	SUPPORTO	PARAPOLVERE	TAMPONE	
		ABA4011	ABR5000	ABS5606	ABT5308	
		ABA4001	ABR5001		ABT5312	

SEAT		MARBELLA (28)			08.86 →	10.98
0.8, 0.9	POSIZIONE	AMMORTIZZATORE	SUPPORTO	PARAPOLVERE	TAMPONE	
		ABA4022	ABR5008	ABS5601		
						

SEAT		MARBELLA Furgonato (028A)			11.86 →	12.93
0.8, 0.9, 0.9 Cat	POSIZIONE	AMMORTIZZATORE	SUPPORTO	PARAPOLVERE	TAMPONE	
		ABA4022	ABR5008	ABS5601		
						

SEAT		TERRA (24)			01.87 →	12.96
0.9	POSIZIONE	AMMORTIZZATORE	SUPPORTO	PARAPOLVERE	TAMPONE	
		ABA4022	ABR5008	ABS5601		
						

SEAT		TERRA Furgonato (024A)			01.87 →	02.96
0.9	POSIZIONE	AMMORTIZZATORE	SUPPORTO	PARAPOLVERE	TAMPONE	
		ABA4022	ABR5008	ABS5601		
SEAT		TOLEDO III (5P2)			10.04 →	
1.6, 1.8 TFSI, 1.9 TDI, 2.0 FSI, 2.0 TDI, 2.0 TDI 16V, 2.0 TFSI	POSIZIONE	AMMORTIZZATORE	SUPPORTO	PARAPOLVERE	TAMPONE	
		ABA4000 ABA4011	ABR5000	ABS5606	ABT5308	
		ABA4001	ABR5001		ABT5312	
SKODA		FABIA I (6Y2)			12.99 →	
1.0, 1.2, 1.4, 1.4 16V, 1.4 TDI, 1.9 SDI, 1.9 TDI, 1.9 TDI RS, 2.0	POSIZIONE	AMMORTIZZATORE	SUPPORTO	PARAPOLVERE	TAMPONE	
		ABA4075				
		ABA4054	ABR5017		ABT5307	
SKODA		FABIA I Combi (6Y5)			11.00 →	
1.2, 1.4, 1.4 16V, 1.4 TDI, 1.9 SDI, 1.9 TDI, 2.0	POSIZIONE	AMMORTIZZATORE	SUPPORTO	PARAPOLVERE	TAMPONE	
		ABA4075				
		ABA4054	ABR5017		ABT5307	
SKODA		FABIA I Praktik (6Y5)			05.03 →	
1.2, 1.4, 1.4 TDI, 1.9 SDI	POSIZIONE	AMMORTIZZATORE	SUPPORTO	PARAPOLVERE	TAMPONE	
		ABA4075				
		ABA4054	ABR5017		ABT5307	

SKODA		FABIA I Tre volumi (6Y3)			04.00 →	
		POSIZIONE	AMMORTIZZATORE	SUPPORTO	PARAPOLVERE	TAMPONE
1.2, 1.4, 1.4 16V, 1.4 TDI, 1.9 SDI, 1.9 TDI, 2.0		ABA4075				
		ABA4054	ABR5017			ABT5307
SKODA		FABIA II (542)			03.07 →	
		POSIZIONE	AMMORTIZZATORE	SUPPORTO	PARAPOLVERE	TAMPONE
1.2, 1.2 12V, 1.2 TDI, 1.2 TSI, 1.4, 1.4 TDI, 1.4 TSI, 1.6, 1.6 TDI, 1.9 TDI		ABA4075				
		ABA4054	ABR5017			ABT5307
SKODA		FABIA II Combi (545)			03.07 →	
		POSIZIONE	AMMORTIZZATORE	SUPPORTO	PARAPOLVERE	TAMPONE
1.2, 1.2 12V, 1.2 TDI, 1.2 TSI, 1.4, 1.4 TDI, 1.4 TSI, 1.6, 1.6 TDI, 1.9 TDI		ABA4075				
		ABA4054	ABR5017			
SKODA		OCTAVIA (1Z3)			06.04 →	
		POSIZIONE	AMMORTIZZATORE	SUPPORTO	PARAPOLVERE	TAMPONE
1.2 TSI, 1.4, 1.4 TSI, 1.6, 1.6 FSI, 1.6 GreenLine, 1.6 LPG, 1.6 TDI, 1.8 TSI, 1.9 TDI, 2.0 FSI, 2.0 TDI, 2.0 TDI 16V		ABA4000 ABA4011	ABR5000		ABS5606	ABT5308
		ABA4001	ABR5001			ABT5311
SKODA		OCTAVIA Combi (1Z5)			08.04 →	
		POSIZIONE	AMMORTIZZATORE	SUPPORTO	PARAPOLVERE	TAMPONE
1.2 TSI, 1.4, 1.4 TSI, 1.6, 1.6 FSI, 1.6 GreenLine, 1.6 LPG, 1.6 TDI, 1.6 TDI 4x4, 1.8 TSI, 1.8 TSI 4x4, 1.9 TDI, 1.9 TDI 4x4, 2.0 FSI, 2.0 FSI 4x4, 2.0 TDI, 2.0 TDI 4x4, 2.0 TDI 16V, 2.0 TDI 16V 4x4, 2.0 TDI 4x4		ABA4000 ABA4011	ABR5000		ABS5606	ABT5308
		ABA4001	ABR5001			ABT5311

SKODA	ROOMSTER (5J, 5J7)			03.06 →	05.15
	POSIZIONE	AMMORTIZZATORE	SUPPORTO	PARAPOLVERE	TAMPONE
1.2, 1.2 TDi, 1.2 TSi, 1.4, 1.4 Tdi, 1.6, 1.6 TDi, 1.9 TDi		ABA4075			
					
SKODA	SUPERB (3T4)			03.08 →	
	POSIZIONE	AMMORTIZZATORE	SUPPORTO	PARAPOLVERE	TAMPONE
1.4 TSI, 1.6 TDi, 1.8 TSI, 1.9 TDi, 2.0 TDi, 2.0 TDi 16V, 2.0 TSI		ABA4011	ABR5000	ABS5606	ABT5308
					
SKODA	SUPERB (3T4)			03.08 →	
	POSIZIONE	AMMORTIZZATORE	SUPPORTO	PARAPOLVERE	TAMPONE
1.8 TSI 4x4, 2.0 TDi 16V 4x4, 2.0 TDi 4x4, 3.6 4x4		ABA4011	ABR5000	ABS5606	ABT5308
					
SKODA	SUPERB Station wagon (3T5)			10.09 →	
	POSIZIONE	AMMORTIZZATORE	SUPPORTO	PARAPOLVERE	TAMPONE
1.4 TSI, 1.6 TDi, 1.8 TSI, 1.9 TDi, 2.0 TDi, 2.0 TSI		ABA4011	ABR5000	ABS5606	ABT5308
					
SKODA	SUPERB Station wagon (3T5)			10.09 →	
	POSIZIONE	AMMORTIZZATORE	SUPPORTO	PARAPOLVERE	TAMPONE
1.8 TSI 4x4, 2.0 TDi 16V 4x4, 2.0 TDi 4x4, 3.6 V6 4x4		ABA4011	ABR5000	ABS5606	ABT5308
					

SKODA		YETI (5L)			05.09 →	
	POSIZIONE	AMMORTIZZATORE	SUPPORTO	PARAPOLVERE	TAMPONE	
1.2 TSI, 1.4 TSI, 1.6 TDI, 1.8 TSI 4x4, 2.0 TDI, 2.0 TDI 4x4		ABA4000	ABR5000	ABS5606	ABT5305	
		ABA4001	ABR5001		ABT5311	
SMART		Fortwo II Cabrio (451)			01.07 →	
	POSIZIONE	AMMORTIZZATORE	SUPPORTO	PARAPOLVERE	TAMPONE	
0.8 CDi, 1.0 Brabus, 1.0 Turbo, 1.0 Turbo Brabus, electric drive		ABA4048	ABR5014	ABS5600		
		ABA4047				
SMART		Fortwo II Coupé (451)			01.07 →	
	POSIZIONE	AMMORTIZZATORE	SUPPORTO	PARAPOLVERE	TAMPONE	
0.8 CDi, 1.0 Brabus, 1.0 Turbo, 1.0 Turbo Brabus, electric drive		ABA4048	ABR5014	ABS5600		
		ABA4047				
TOYOTA		AYGO (WNB1_, KGB1_)			02.05 →	
	POSIZIONE	AMMORTIZZATORE	SUPPORTO	PARAPOLVERE	TAMPONE	
1.0, 1.4 HDi		ABA4012 (DX) ABA4013 (SX)	ABR5007	ABS5612	ABT5310	
		ABA4014				
TOYOTA		YARIS III (_P13_)			10.12 →	
	POSIZIONE	AMMORTIZZATORE	SUPPORTO	PARAPOLVERE	TAMPONE	
1.0, 1.3, 1.5, 1.4 D-4D, 1.5 Hybrid		ABA4044 (DX) ABA4045 (SX)	ABR5013	ABS5618		
		ABA4046				

VW		CADDY III Furgonato (2KA, 2CA)			03.04 →	
		POSIZIONE	AMMORTIZZATORE	SUPPORTO	PARAPOLVERE	TAMPONE
1.2 TSI, 1.6 TDI			ABA4011	ABR5000	ABS5606	ABT5308
						
VW		CADDY III Furgonato (2KA, 2CA)			03.04 →	
		POSIZIONE	AMMORTIZZATORE	SUPPORTO	PARAPOLVERE	TAMPONE
1.4, 1.4 16V, 1.6, 1.9 TDI, 2.0 SDI, 2.0 TDI			ABA4000 ABA4011	ABR5000	ABS5606	ABT5305
						
VW		CADDY III Furgonato (2KA, 2CA)			03.04 →	
		POSIZIONE	AMMORTIZZATORE	SUPPORTO	PARAPOLVERE	TAMPONE
1.6 BiFuel, 2.0 TDI 16V 4motion, 2.0 TDI 4motion			ABA4011	ABR5000	ABS5606	ABT5308
						
VW		CADDY III Furgonato (2KA, 2CA)			03.04 →	
		POSIZIONE	AMMORTIZZATORE	SUPPORTO	PARAPOLVERE	TAMPONE
1.9 TDI 4motion, 2.0 EcoFuel			ABA4000 ABA4011	ABR5000	ABS5606	ABT5305
						
VW		CADDY III Furgonato (2KA, 2CA)			03.04 →	
		POSIZIONE	AMMORTIZZATORE	SUPPORTO	PARAPOLVERE	TAMPONE
2.0 TDI 16V			ABA4011	ABR5000	ABS5606	ABT5308
						



VW		CADDY III Furgonato (2KA, 2CA)			03.04 →	
		POSIZIONE	AMMORTIZZATORE	SUPPORTO	PARAPOLVERE	TAMPONE
1.2 TSI, 1.6 TDI, 2.0 TDI 16V			ABA4000 ABA4011	ABR5000	ABS5606	ABT5305
						
VW		CADDY III Furgonato (2KA, 2CA)			03.04 →	
		POSIZIONE	AMMORTIZZATORE	SUPPORTO	PARAPOLVERE	TAMPONE
1.4, 1.4 16V, 1.6, 1.9 TDI, 2.0 SDI, 2.0 TDI			ABA4000 ABA4011	ABR5000	ABS5606	ABT5305
						
VW		CADDY III Furgonato (2KA, 2CA)			03.04 →	
		POSIZIONE	AMMORTIZZATORE	SUPPORTO	PARAPOLVERE	TAMPONE
1.6 BiFuel, 1.9 TDI 4motion			ABA4000 ABA4011	ABR5000	ABS5606	ABT5305
						
VW		CADDY III Furgonato (2KA, 2CA)			03.04 →	
		POSIZIONE	AMMORTIZZATORE	SUPPORTO	PARAPOLVERE	TAMPONE
2.0 EcoFuel			ABA4000 ABA4011	ABR5000	ABS5606	ABT5305
						
VW		CADDY III Furgonato (2KA, 2CA)			03.04 →	
		POSIZIONE	AMMORTIZZATORE	SUPPORTO	PARAPOLVERE	TAMPONE
2.0 TDI 16V 4motion, 2.0 TDI 4motion			ABA4011	ABR5000	ABS5606	ABT5308
						



VW		CC (358)			11.11 →	
	POSIZIONE	AMMORTIZZATORE	SUPPORTO	PARAPOLVERE	TAMPONE	
1.4 TSI, 1.8 TSI, 2.0 TDI, 2.0 TDI 4motion, 2.0 TSI, 3.6 FSI 4motion		ABA4011	ABR5000	ABS5606	ABT5308	
		ABA4001	ABR5001		ABT5311	
VW		EOS (1F7, 1F8)			03.06 →	
	POSIZIONE	AMMORTIZZATORE	SUPPORTO	PARAPOLVERE	TAMPONE	
1.4 TSI, 1.6 FSI, 2.0 FSI, 2.0 TDI, 2.0 TDI 16V, 2.0 TFSI, 2.0 TSI, 3.2 V6, 3.6 V6		ABA4011	ABR5000	ABS5606	ABT5308	
						
VW		FOX (5Z1)			04.05 →	
	POSIZIONE	AMMORTIZZATORE	SUPPORTO	PARAPOLVERE	TAMPONE	
1.2 i, 1.4 i, 1.4 Tdi		ABA4075				
		ABA4054				
VW		GOLF PLUS (5M1, 521)			01.05 →	
	POSIZIONE	AMMORTIZZATORE	SUPPORTO	PARAPOLVERE	TAMPONE	
1.2 TSI, 1.4 16V, 1.4 FSI, 1.4 TSI, 1.6, 1.6 BiFuel, 1.6 FSI, 1.6 Multifuel, 1.6 TDI, 1.9 TDI, 2.0 FSI, 2.0 TDI, 2.0 TDI 16V		ABA4000 ABA4011	ABR5000	ABS5606	ABT5308	
		ABA4001	ABR5001		ABT5311	
VW		GOLF V (1K1)			10.03 →	
	POSIZIONE	AMMORTIZZATORE	SUPPORTO	PARAPOLVERE	TAMPONE	
1.4 16V, 1.4 FSI, 1.4 TSI, 1.6, 1.6 FSI, 1.6 MultiFuel, 1.9 TDI, 1.9 TDI 4motion, 2.0, 2.0 FSI, 2.0 FSI 4motion, 2.0 SDI, 2.0 TDI, 2.0 TDI 4motion, 2.0 TDI 16V, 2.0 TDI 16V 4motion		ABA4000 ABA4011	ABR5000	ABS5606	ABT5308	
		ABA4001	ABR5001		ABT5311	

VW	GOLF V Variant (1K5)			06.07 →	07.09
	POSIZIONE	AMMORTIZZATORE	SUPPORTO	PARAPOLVERE	TAMPONE
1.4, 1.4 TSI, 1.6, 1.6 MultiFuel, 1.9 TDI, 1.9 TDI 4motion, 2.0, 2.0 TDI, 2.0 TDI 16V, 2.0 TDI 4motion		ABA4000 ABA4011	ABR5000	ABS5606	ABT5308
		ABA4001	ABR5001		ABT5311
VW	GOLF VI (5K1)			10.08 →	11.13
	POSIZIONE	AMMORTIZZATORE	SUPPORTO	PARAPOLVERE	TAMPONE
1.2 TSI, 1.4, 1.4 TSI, 1.6, 1.6 BiFuel, 1.6 MultiFuel, 1.6 TDI, 1.8 TSI, 2.0 TDI, 2.0 TDI 4motion		ABA4000 ABA4011	ABR5000	ABS5606	ABT5308
		ABA4001	ABR5001		ABT5311
VW	GOLF VI Variant (AJ5)			07.09 →	07.13
	POSIZIONE	AMMORTIZZATORE	SUPPORTO	PARAPOLVERE	TAMPONE
1.2 TSI, 1.4, 1.4 TSI, 1.6, 1.6 MultiFuel, 1.6 TDI, 1.6 TDI 4motion, 2.0, 2.0 TDI		ABA4000 ABA4011	ABR5000	ABS5606	ABT5308
		ABA4001	ABR5001		ABT5311
VW	JETTA III (1K2)			08.05 →	10.10
	POSIZIONE	AMMORTIZZATORE	SUPPORTO	PARAPOLVERE	TAMPONE
1.4 TSI, 1.6, 1.6 FSI, 1.6 MultiFuel, 1.6 TDI, 1.9 TDI, 2.0 FSI, 2.0 TDI, 2.0 TDI 16V, 2.0 TFSI, 2.5 FSI		ABA4000 ABA4011	ABR5000	ABS5606	ABT5308
		ABA4001	ABR5001		ABT5311
VW	JETTA IV (162, 163)			04.10 →	
	POSIZIONE	AMMORTIZZATORE	SUPPORTO	PARAPOLVERE	TAMPONE
1.2 TSI, 1.4 TSI, 1.4 TSI Hybrid, 1.6, 1.6 TDI, 2.0, 2.0 TDI, 2.0 TSI, 2.5 FSI		ABA4000 ABA4011	ABR5000	ABS5606	ABT5308
		ABA4001	ABR5001		ABT5311

VW		PASSAT (362)			08.10 →	
	POSIZIONE	AMMORTIZZATORE	SUPPORTO	PARAPOLVERE	TAMPONE	
1.4 TSI, 1.4 TSI EcoFuel, 1.4 TSI Multi-Fuel, 1.6 TDI, 1.8 TSI, 2.0 TDI, 2.0 TDI 4motion, 2.0 TSI, 3.6 FSI 4motion		ABA4011	ABR5000	ABS5606	ABT5308	
		ABA4001	ABR5001		ABT5311	
VW		PASSAT (3C2)			03.05 →	
	POSIZIONE	AMMORTIZZATORE	SUPPORTO	PARAPOLVERE	TAMPONE	
1.4 TSI, 1.4 TSI EcoFuel, 1.6, 1.6 FSI, 1.6 TDI, 1.8 TSI, 1.9 TDI, 2.0 BlueTDI, 2.0 FSI, 2.0 FSI 4motion, 2.0 TDI, 2.0 TDI 4motion, 2.0 TDI 16V, 2.0 TDI 16V 4motion, 2.0 TDI 4motion, 2.0 TFSI, 3.2 FSI 4motion		ABA4011	ABR5000	ABS5606	ABT5308	
		ABA4001	ABR5001		ABT5311	
VW		PASSAT CC (357)			05.08 →	01.12
	POSIZIONE	AMMORTIZZATORE	SUPPORTO	PARAPOLVERE	TAMPONE	
1.4 TSI MultiFuel, 1.8 TSI, 2.0 BlueTDI, 2.0 TDI, 2.0 TDI 4motion, 2.0 TDI 4motion, 2.0 TSI, 3.6 4motion, 3.6 FSI 4motion		ABA4011	ABR5000	ABS5606	ABT5308	
		ABA4001	ABR5001		ABT5311	
VW		PASSAT Variant (365)			08.10 →	
	POSIZIONE	AMMORTIZZATORE	SUPPORTO	PARAPOLVERE	TAMPONE	
1.4 TSI, 1.4 TSI EcoFuel, 1.4 TSI Multi-Fuel, 1.6 TDI, 1.8 TSI, 2.0 TDI, 2.0 TDI 4motion, 2.0 TSI, 3.6 FSI 4motion		ABA4011	ABR5000	ABS5606	ABT5308	
		ABA4001	ABR5001		ABT5311	
VW		PASSAT Variant (3C5)			08.05 →	
	POSIZIONE	AMMORTIZZATORE	SUPPORTO	PARAPOLVERE	TAMPONE	
1.4 TSI, 1.4 TSI EcoFuel, 1.6, 1.6 FSI, 1.6 TDI, 1.8 TSI, 1.9 TDI, 2.0 BlueTDI, 2.0 FSI, 2.0 FSI 4motion, 2.0 TDI, 2.0 TDI 4motion, 2.0 TDI 16V, 2.0 TDI 16V 4motion, 2.0 TDI 4motion, 2.0 TFSI, 3.2 FSI 4motion		ABA4011	ABR5000	ABS5606	ABT5308	
		ABA4001	ABR5001		ABT5311	

VW		POLO (6R, 6C)			06.09 →	
		POSIZIONE	AMMORTIZZATORE	SUPPORTO	PARAPOLVERE	TAMPONE
1.2, 1.2 TDI, 1.2 TSI, 1.4, 1.4 BiFuel, 1.4 TSI, 1.6 BiFuel, 1.6 TDI		ABA4039	ABR5011	ABS5604	ABT5300 ABT5302	
		ABA4054	ABR5017		ABT5307	
VW		POLO (9N_)			10.01 →	11.09
		POSIZIONE	AMMORTIZZATORE	SUPPORTO	PARAPOLVERE	TAMPONE
1.2, 1.2 12V, 1.4 16V, 1.4 FSI, 1.4 TDI, 1.6 16V, 1.8 GTI, 1.9 SDI, 1.9 TDI		ABA4075				
		ABA4054	ABR5017			ABT5307
VW		POLO Tre volumi (9A4)			11.02 →	42.012
		POSIZIONE	AMMORTIZZATORE	SUPPORTO	PARAPOLVERE	TAMPONE
1.4, 1.4 TDI, 1.6, 1.9 SDI		ABA4075				
		ABA4054	ABR5017			ABT5307
VW		SCIROCCO (137, 138)			05.08 →	
		POSIZIONE	AMMORTIZZATORE	SUPPORTO	PARAPOLVERE	TAMPONE
1.4 TSI, 2.0 TDI, 2.0 TSI		ABA4011	ABR5000	ABS5606	ABT5308	
		ABA4001	ABR5001		ABT5306	
VW		SHARAN (7N)			05.10 →	
		POSIZIONE	AMMORTIZZATORE	SUPPORTO	PARAPOLVERE	TAMPONE
1.4 TSI, 1.8 TSI 2.0 TDI, 2.0 TDI 4motion, 2.0 TSI		ABA4011	ABR5000	ABS5606	ABT5308	
		ABA4001	ABR5001		ABT5313	

VW	TOURAN (1T1, 1T2)			02.03 →	05.10
1.2 TSI, 1.4 FSI, 1.4 TSI, 1.4 TSI EcoFuel, 1.6, 1.6 FSI, 1.6 TDI, 1.9 TDI, 2.0 EcoFuel, 2.0 FSI, 2.0 TDI, 2.0 TDI 16V	POSIZIONE	AMMORTIZZATORE	SUPPORTO	PARAPOLVERE	TAMPONE
		ABA4011	ABR5000	ABS5606	ABT5308
	ABA4001	ABR5001		ABT5311	

VW	TOURAN (1T3)			05.10 →	
1.4 TSI, 1.4 TSI EcoFuel, 1.6 TDI, 2.0 TDI	POSIZIONE	AMMORTIZZATORE	SUPPORTO	PARAPOLVERE	TAMPONE
		ABA4011	ABR5000	ABS5606	ABT5308
	ABA4001	ABR5001		ABT5311	

DETTAGLIO PRODOTTI - AMMORTIZZATORI

PRODUCT DETAILS - SHOCK ABSORBERS

DETAILS PRODUITS - AMORTISSEURS



ABA4000

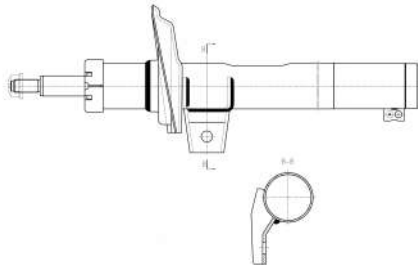

ABA4001

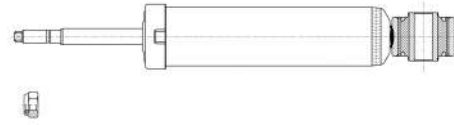

Caratteristiche	
Zona di montaggio:	Anteriore
Sistema:	A doppio tubo
Tipologia:	A pressione del gas
Fissaggio Superiore:	SPINA
Fissaggio Inferiore:	COLLARE
Diametro Corpo:	50
Diametro Stelo:	22
Interasse Boccole:	
Note:	

Caratteristiche	
Zona di montaggio:	Posteriore
Sistema:	A doppio tubo
Tipologia:	A pressione del gas
Fissaggio Superiore:	SPINA
Fissaggio Inferiore:	OCCHIELLO
Diametro Corpo:	45
Diametro Stelo:	12,5
Interasse Boccole:	37
Note:	

ABA4002

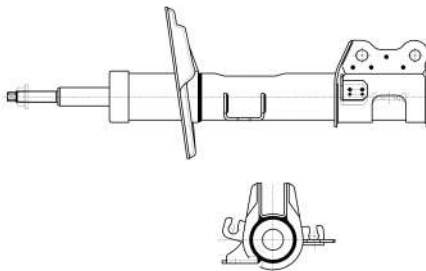

ABA4003

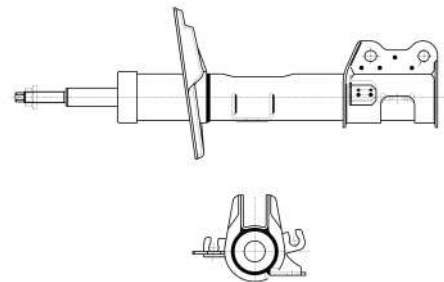

Caratteristiche	
Zona di montaggio:	Anteriore DX
Sistema:	A doppio tubo
Tipologia:	A pressione del gas
Fissaggio Superiore:	SPINA
Fissaggio Inferiore:	STAFFA
Diametro Corpo:	51
Diametro Stelo:	20
Interasse Boccole:	
Note:	

Caratteristiche	
Zona di montaggio:	Anteriore SX
Sistema:	A doppio tubo
Tipologia:	A pressione del gas
Fissaggio Superiore:	SPINA
Fissaggio Inferiore:	STAFFA
Diametro Corpo:	51
Diametro Stelo:	20
Interasse Boccole:	
Note:	

ABA4004



ABA4005

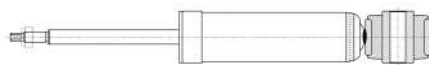

Caratteristiche	
Zona di montaggio:	Posteriore
Sistema:	A doppio tubo
Tipologia:	A pressione del gas
Fissaggio Superiore:	SPINA
Fissaggio Inferiore:	OCCHIELLO
Diametro Corpo:	38
Diametro Stelo:	12,5
Interasse Boccole:	52
Note:	

Caratteristiche	
Zona di montaggio:	Posteriore
Sistema:	A doppio tubo
Tipologia:	A pressione del gas
Fissaggio Superiore:	SPINA
Fissaggio Inferiore:	OCCHIELLO
Diametro Corpo:	38
Diametro Stelo:	11
Interasse Boccole:	40
Note:	

ABA4006

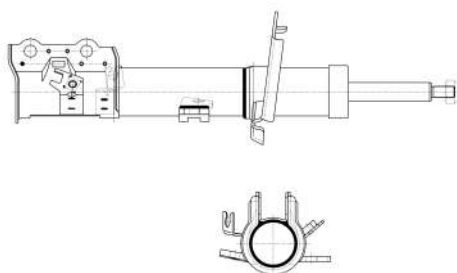

ABA4007

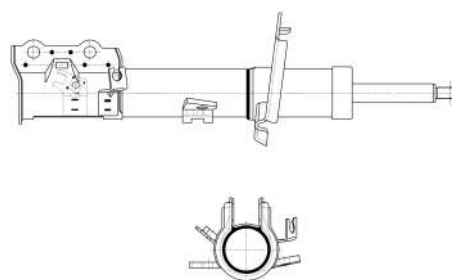

Caratteristiche	
Zona di montaggio:	Anteriore DX
Sistema:	A doppio tubo
Tipologia:	A pressione del gas
Fissaggio Superiore:	SPINA
Fissaggio Inferiore:	STAFFA
Diametro Corpo:	51
Diametro Stelo:	20
Interasse Boccole:	
Note:	

Caratteristiche	
Zona di montaggio:	Anteriore SX
Sistema:	A doppio tubo
Tipologia:	A pressione del gas
Fissaggio Superiore:	SPINA
Fissaggio Inferiore:	STAFFA
Diametro Corpo:	51
Diametro Stelo:	20
Interasse Boccole:	
Note:	

ABA4008

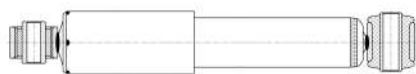

ABA4011

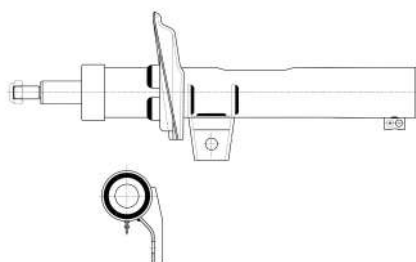

Caratteristiche	
Zona di montaggio:	Posteriore
Sistema:	A doppio tubo
Tipologia:	A pressione del gas
Fissaggio Superiore:	OCCHIELLO
Fissaggio Inferiore:	OCCHIELLO
Diametro Corpo:	48
Diametro Stelo:	-
Interasse Boccole:	32 / 44
Note:	

Caratteristiche	
Zona di montaggio:	Anteriore
Sistema:	A doppio tubo
Tipologia:	A pressione del gas
Fissaggio Superiore:	SPINA
Fissaggio Inferiore:	COLLARE
Diametro Corpo:	54,5
Diametro Stelo:	25
Interasse Boccole:	
Note:	

ABA4012

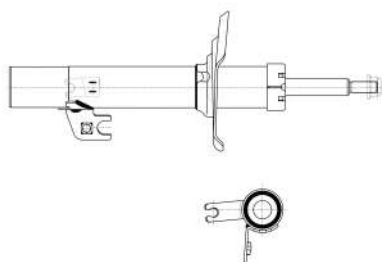

ABA4013

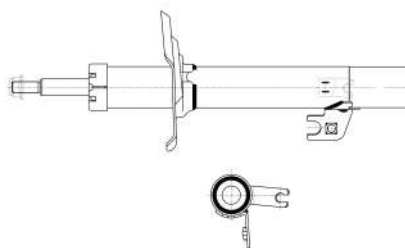

Caratteristiche	
Zona di montaggio:	Anteriore SX
Sistema:	A doppio tubo
Tipologia:	A pressione del gas
Fissaggio Superiore:	SPINA
Fissaggio Inferiore:	COLLARE
Diametro Corpo:	44,5
Diametro Stelo:	18
Interasse Boccole:	
Note:	

Caratteristiche	
Zona di montaggio:	Anteriore DX
Sistema:	A doppio tubo
Tipologia:	A pressione del gas
Fissaggio Superiore:	SPINA
Fissaggio Inferiore:	COLLARE
Diametro Corpo:	44,5
Diametro Stelo:	18
Interasse Boccole:	
Note:	

ABA4014



ABA4015



Caratteristiche	
Zona di montaggio:	Posteriore
Sistema:	A doppio tubo
Tipologia:	A pressione del gas
Fissaggio Superiore:	SPINA
Fissaggio Inferiore:	OCCHIELLO
Diametro Corpo:	38
Diametro Stelo:	11
Interasse Boccole:	40
Note:	

Caratteristiche	
Zona di montaggio:	Posteriore
Sistema:	A doppio tubo
Tipologia:	A pressione del gas
Fissaggio Superiore:	OCCHIELLO
Fissaggio Inferiore:	OCCHIELLO
Diametro Corpo:	48
Diametro Stelo:	-
Interasse Boccole:	32 / 44
Note:	

ABA4016

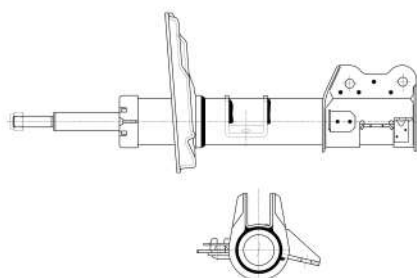

ABA4017

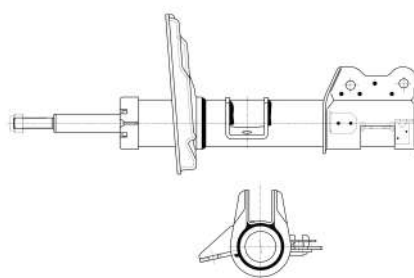

Caratteristiche	
Zona di montaggio:	Anteriore SX
Sistema:	A doppio tubo
Tipologia:	A pressione del gas
Fissaggio Superiore:	SPINA
Fissaggio Inferiore:	STAFFA
Diametro Corpo:	51
Diametro Stelo:	20
Interasse Boccole:	
Note:	

Caratteristiche	
Zona di montaggio:	Anteriore DX
Sistema:	A doppio tubo
Tipologia:	A pressione del gas
Fissaggio Superiore:	SPINA
Fissaggio Inferiore:	STAFFA
Diametro Corpo:	51
Diametro Stelo:	20
Interasse Boccole:	
Note:	

ABA4018

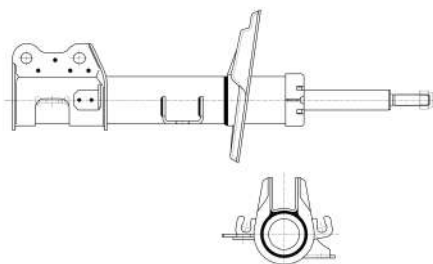

ABA4019

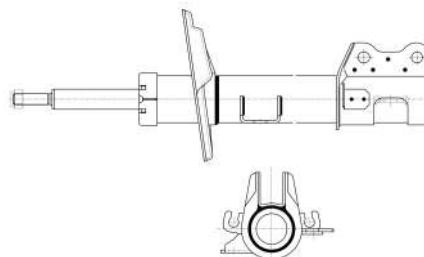

Caratteristiche	
Zona di montaggio:	Anteriore SX
Sistema:	A doppio tubo
Tipologia:	A pressione del gas
Fissaggio Superiore:	SPINA
Fissaggio Inferiore:	STAFFA
Diametro Corpo:	51
Diametro Stelo:	22
Interasse Boccole:	
Note:	

Caratteristiche	
Zona di montaggio:	Anteriore DX
Sistema:	A doppio tubo
Tipologia:	A pressione del gas
Fissaggio Superiore:	SPINA
Fissaggio Inferiore:	STAFFA
Diametro Corpo:	51
Diametro Stelo:	22
Interasse Boccole:	
Note:	

ABA4020

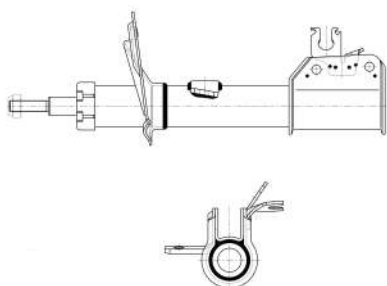

ABA4021

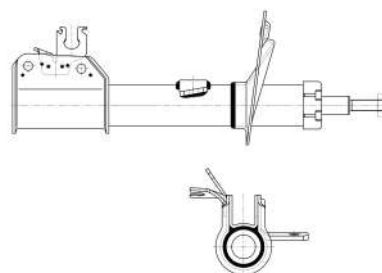

Caratteristiche	
Zona di montaggio:	Anteriore SX
Sistema:	A doppio tubo
Tipologia:	A pressione del gas
Fissaggio Superiore:	SPINA
Fissaggio Inferiore:	STAFFA
Diametro Corpo:	45
Diametro Stelo:	20
Interasse Boccole:	
Note:	

Caratteristiche	
Zona di montaggio:	Anteriore DX
Sistema:	A doppio tubo
Tipologia:	A pressione del gas
Fissaggio Superiore:	SPINA
Fissaggio Inferiore:	STAFFA
Diametro Corpo:	45
Diametro Stelo:	20
Interasse Boccole:	
Note:	

ABA4022

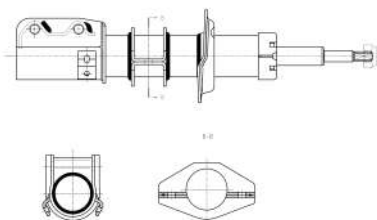

ABA4023

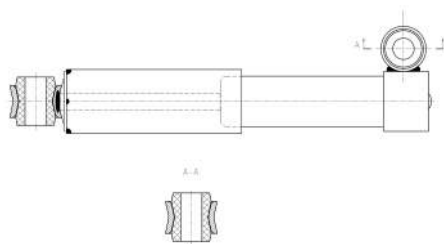

Caratteristiche	
Zona di montaggio:	Anteriore
Sistema:	A doppio tubo
Tipologia:	A pressione del gas
Fissaggio Superiore:	SPINA
Fissaggio Inferiore:	STAFFA
Diametro Corpo:	45
Diametro Stelo:	20
Interasse Boccole:	
Note:	

Caratteristiche	
Zona di montaggio:	Posteriore
Sistema:	A doppio tubo
Tipologia:	A pressione del gas
Fissaggio Superiore:	OCCHIELLO
Fissaggio Inferiore:	OCCHIELLO
Diametro Corpo:	48
Diametro Stelo:	12,5
Interasse Boccole:	36,5
Note:	

ABA4024

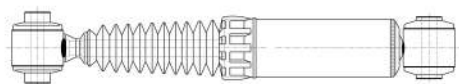

ABA4025

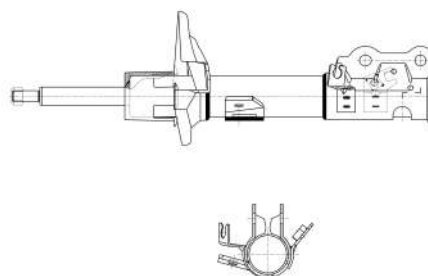

Caratteristiche	
Zona di montaggio:	Posteriore
Sistema:	A doppio tubo
Tipologia:	A pressione del gas
Fissaggio Superiore:	OCCHIELLO
Fissaggio Inferiore:	OCCHIELLO
Diametro Corpo:	45
Diametro Stelo:	-
Interasse Boccole:	48 / 55
Note:	

Caratteristiche	
Zona di montaggio:	Anteriore DX
Sistema:	A doppio tubo
Tipologia:	A pressione del gas
Fissaggio Superiore:	SPINA
Fissaggio Inferiore:	STAFFA
Diametro Corpo:	45
Diametro Stelo:	20
Interasse Boccole:	
Note:	

ABA4026

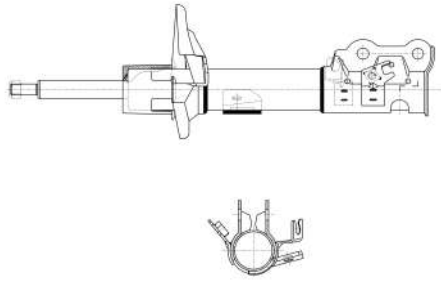

ABA4027

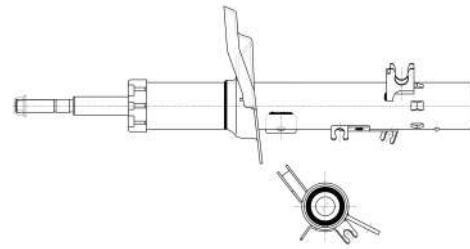

Caratteristiche	
Zona di montaggio:	Anteriore SX
Sistema:	A doppio tubo
Tipologia:	A pressione del gas
Fissaggio Superiore:	SPINA
Fissaggio Inferiore:	STAFFA
Diametro Corpo:	45
Diametro Stelo:	20
Interasse Boccole:	
Note:	

Caratteristiche	
Zona di montaggio:	Anteriore DX
Sistema:	A doppio tubo
Tipologia:	A pressione del gas
Fissaggio Superiore:	SPINA
Fissaggio Inferiore:	COLLARE
Diametro Corpo:	51
Diametro Stelo:	20
Interasse Boccole:	
Note:	

ABA4028

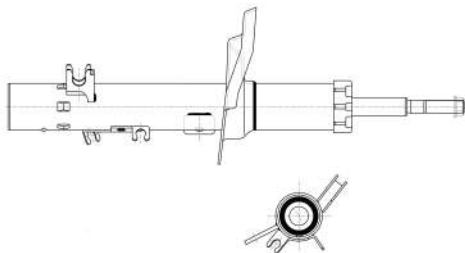

ABA4029

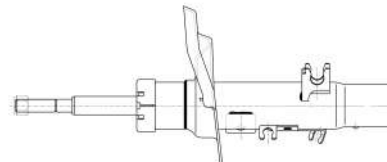

Caratteristiche	
Zona di montaggio:	Anteriore SX
Sistema:	A doppio tubo
Tipologia:	A pressione del gas
Fissaggio Superiore:	SPINA
Fissaggio Inferiore:	COLLARE
Diametro Corpo:	51
Diametro Stelo:	20
Interasse Boccole:	
Note:	

Caratteristiche	
Zona di montaggio:	Anteriore DX
Sistema:	A doppio tubo
Tipologia:	A pressione del gas
Fissaggio Superiore:	SPINA
Fissaggio Inferiore:	COLLARE
Diametro Corpo:	51
Diametro Stelo:	20
Interasse Boccole:	
Note:	

ABA4030

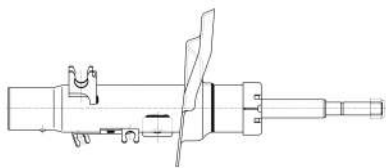

ABA4032



Caratteristiche	
Zona di montaggio:	Anteriore SX
Sistema:	A doppio tubo
Tipologia:	A pressione del gas
Fissaggio Superiore:	SPINA
Fissaggio Inferiore:	COLLARE
Diametro Corpo:	51
Diametro Stelo:	20
Interasse Boccole:	
Note:	φ 46 mm attacco inferiore

Caratteristiche	
Zona di montaggio:	Posteriore
Sistema:	A doppio tubo
Tipologia:	A pressione del gas
Fissaggio Superiore:	OCCHIELLO
Fissaggio Inferiore:	OCCHIELLO
Diametro Corpo:	48
Diametro Stelo:	-
Interasse Boccole:	38
Note:	

ABA4033

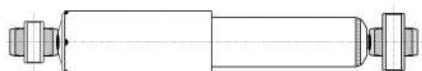

ABA4034

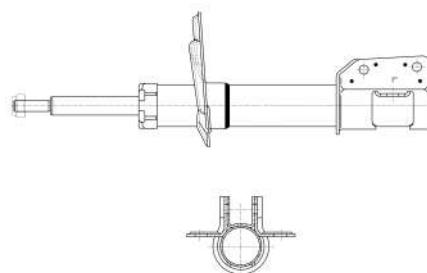

Caratteristiche	
Zona di montaggio:	Posteriore
Sistema:	A doppio tubo
Tipologia:	A pressione del gas
Fissaggio Superiore:	OCCHIELLO
Fissaggio Inferiore:	OCCHIELLO
Diametro Corpo:	48
Diametro Stelo:	-
Interasse Boccole:	32 / 44
Note:	

Caratteristiche	
Zona di montaggio:	Anteriore
Sistema:	A doppio tubo
Tipologia:	A pressione del gas
Fissaggio Superiore:	SPINA
Fissaggio Inferiore:	STAFFA
Diametro Corpo:	45
Diametro Stelo:	20
Interasse Boccole:	
Note:	

ABA4035

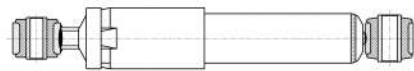

ABA4036

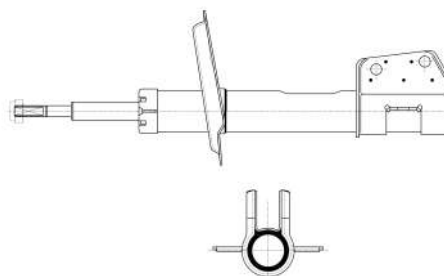

Caratteristiche	
Zona di montaggio:	Posteriore
Sistema:	A doppio tubo
Tipologia:	A pressione del gas
Fissaggio Superiore:	OCCHIELLO
Fissaggio Inferiore:	OCCHIELLO
Diametro Corpo:	48
Diametro Stelo:	-
Interasse Boccole:	32 / 38
Note:	

Caratteristiche	
Zona di montaggio:	Anteriore
Sistema:	A doppio tubo
Tipologia:	A pressione del gas
Fissaggio Superiore:	SPINA
Fissaggio Inferiore:	STAFFA
Diametro Corpo:	45
Diametro Stelo:	20
Interasse Boccole:	
Note:	

ABA4037

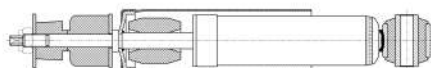

ABA4038

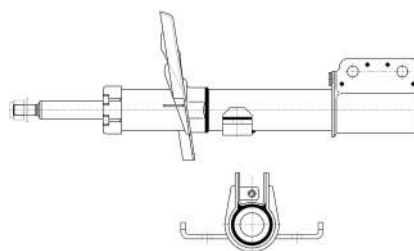

Caratteristiche	
Zona di montaggio:	Posteriore
Sistema:	A doppio tubo
Tipologia:	A pressione del gas
Fissaggio Superiore:	SPINA
Fissaggio Inferiore:	OCCHIELLO
Diametro Corpo:	48
Diametro Stelo:	12,5
Interasse Boccole:	40
Note:	

Caratteristiche	
Zona di montaggio:	Anteriore
Sistema:	A doppio tubo
Tipologia:	A pressione del gas
Fissaggio Superiore:	SPINA
Fissaggio Inferiore:	STAFFA
Diametro Corpo:	45
Diametro Stelo:	20
Interasse Boccole:	
Note:	

ABA4039

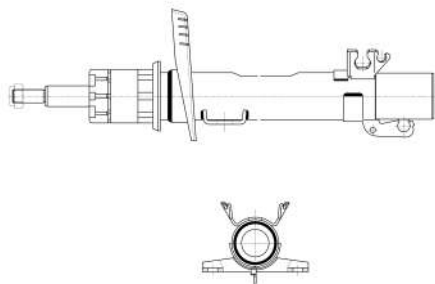

ABA4040

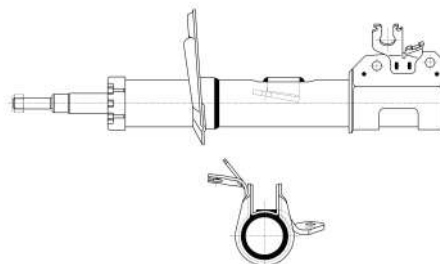

Caratteristiche	
Zona di montaggio:	Anteriore
Sistema:	A doppio tubo
Tipologia:	A pressione del gas
Fissaggio Superiore:	SPINA
Fissaggio Inferiore:	COLLARE
Diametro Corpo:	50
Diametro Stelo:	22
Interasse Boccole:	
Note:	

Caratteristiche	
Zona di montaggio:	Anteriore DX
Sistema:	A doppio tubo
Tipologia:	A pressione del gas
Fissaggio Superiore:	SPINA
Fissaggio Inferiore:	STAFFA
Diametro Corpo:	51
Diametro Stelo:	22
Interasse Boccole:	
Note:	

ABA4041

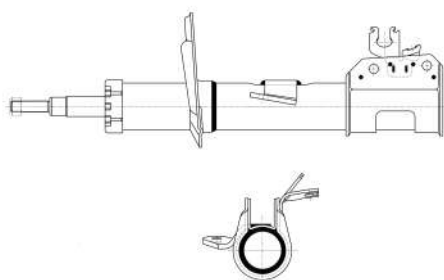

ABA4042

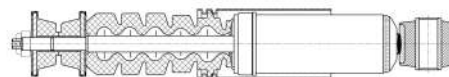

Caratteristiche	
Zona di montaggio:	Anteriore SX
Sistema:	A doppio tubo
Tipologia:	A pressione del gas
Fissaggio Superiore:	SPINA
Fissaggio Inferiore:	STAFFA
Diametro Corpo:	51
Diametro Stelo:	22
Interasse Boccole:	
Note:	

Caratteristiche	
Zona di montaggio:	Posteriore
Sistema:	A doppio tubo
Tipologia:	A pressione del gas
Fissaggio Superiore:	SPINA
Fissaggio Inferiore:	OCCHIELLO
Diametro Corpo:	54
Diametro Stelo:	12,5
Interasse Boccole:	40
Note:	

ABA4043

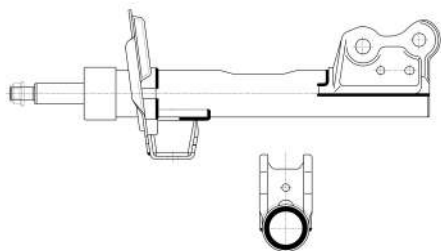

ABA4044

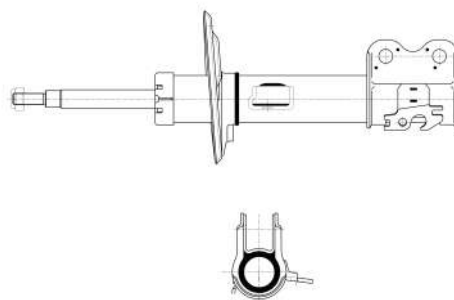

Caratteristiche	
Zona di montaggio:	Anteriore
Sistema:	A doppio tubo
Tipologia:	A pressione del gas
Fissaggio Superiore:	SPINA
Fissaggio Inferiore:	STAFFA
Diametro Corpo:	50
Diametro Stelo:	22
Interasse Boccole:	
Note:	

Caratteristiche	
Zona di montaggio:	Anteriore DX
Sistema:	A doppio tubo
Tipologia:	A pressione del gas
Fissaggio Superiore:	SPINA
Fissaggio Inferiore:	STAFFA
Diametro Corpo:	51
Diametro Stelo:	20
Interasse Boccole:	
Note:	

ABA4045

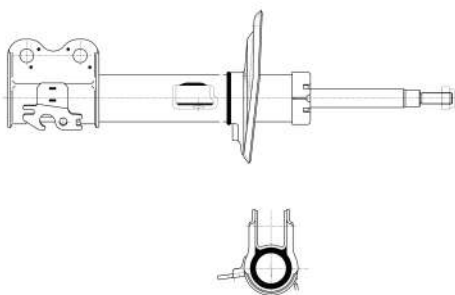

ABA4046



Caratteristiche	
Zona di montaggio:	Anteriore SX
Sistema:	A doppio tubo
Tipologia:	A pressione del gas
Fissaggio Superiore:	SPINA
Fissaggio Inferiore:	STAFFA
Diametro Corpo:	51
Diametro Stelo:	20
Interasse Boccole:	
Note:	

Caratteristiche	
Zona di montaggio:	Posteriore
Sistema:	A doppio tubo
Tipologia:	A pressione del gas
Fissaggio Superiore:	SPINA
Fissaggio Inferiore:	OCCHIELLO
Diametro Corpo:	38
Diametro Stelo:	12,5
Interasse Boccole:	40
Note:	

ABA4047



ABA4048

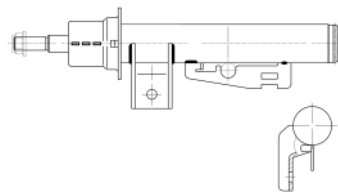

Caratteristiche	
Zona di montaggio:	Posteriore
Sistema:	A doppio tubo
Tipologia:	A pressione del gas
Fissaggio Superiore:	SPINA
Fissaggio Inferiore:	OCCHIELLO
Diametro Corpo:	40
Diametro Stelo:	11
Interasse Boccole:	44
Note:	

Caratteristiche	
Zona di montaggio:	Anteriore
Sistema:	A doppio tubo
Tipologia:	A pressione del gas
Fissaggio Superiore:	SPINA
Fissaggio Inferiore:	COLLARE
Diametro Corpo:	41
Diametro Stelo:	18
Interasse Boccole:	
Note:	

ABA4049



ABA4050

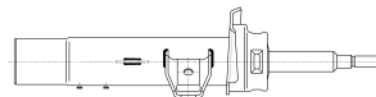

Caratteristiche	
Zona di montaggio:	Posteriore
Sistema:	A doppio tubo
Tipologia:	A pressione del gas
Fissaggio Superiore:	SPINA
Fissaggio Inferiore:	SPINA
Diametro Corpo:	45
Diametro Stelo:	15
Interasse Boccole:	
Note:	

Caratteristiche	
Zona di montaggio:	Anteriore SX
Sistema:	A doppio tubo
Tipologia:	A pressione del gas
Fissaggio Superiore:	SPINA
Fissaggio Inferiore:	COLLARE
Diametro Corpo:	52
Diametro Stelo:	22
Interasse Boccole:	
Note:	

ABA4051

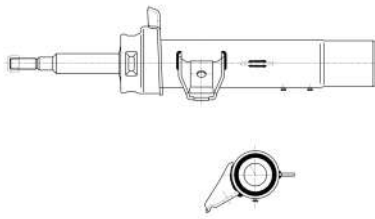

ABA4052

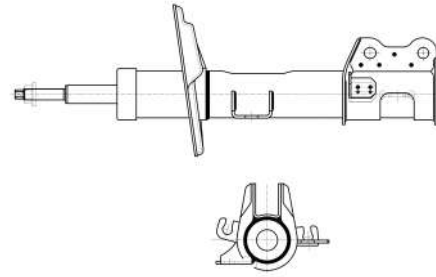

Caratteristiche	
Zona di montaggio:	Anteriore DX
Sistema:	A doppio tubo
Tipologia:	A pressione del gas
Fissaggio Superiore:	SPINA
Fissaggio Inferiore:	COLLARE
Diametro Corpo:	52
Diametro Stelo:	22
Interasse Boccole:	
Note:	

Caratteristiche	
Zona di montaggio:	Anteriore DX
Sistema:	A doppio tubo
Tipologia:	A pressione del gas
Fissaggio Superiore:	SPINA
Fissaggio Inferiore:	STAFFA
Diametro Corpo:	51
Diametro Stelo:	20
Interasse Boccole:	
Note:	

ABA4053

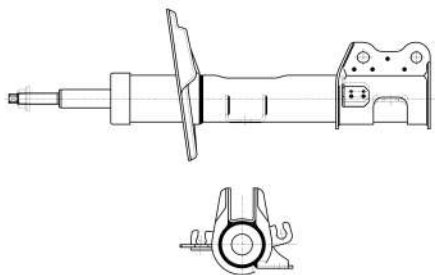

ABA4054



Caratteristiche	
Zona di montaggio:	Anteriore SX
Sistema:	A doppio tubo
Tipologia:	A pressione del gas
Fissaggio Superiore:	SPINA
Fissaggio Inferiore:	STAFFA
Diametro Corpo:	51
Diametro Stelo:	20
Interasse Boccole:	
Note:	

Caratteristiche	
Zona di montaggio:	Posteriore
Sistema:	A doppio tubo
Tipologia:	A pressione del gas
Fissaggio Superiore:	SPINA
Fissaggio Inferiore:	OCCHIELLO
Diametro Corpo:	38
Diametro Stelo:	12,5
Interasse Boccole:	45
Note:	

ABA4055

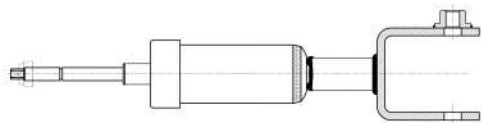

ABA4056

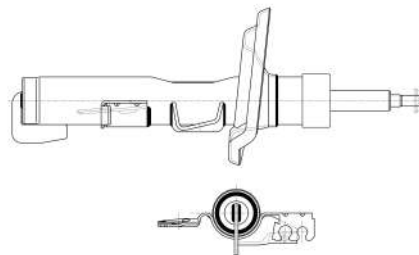

Caratteristiche	
Zona di montaggio:	Posteriore
Sistema:	A doppio tubo
Tipologia:	A pressione del gas
Fissaggio Superiore:	SPINA
Fissaggio Inferiore:	STAFFA
Diametro Corpo:	45
Diametro Stelo:	16
Interasse Boccole:	
Note:	

Caratteristiche	
Zona di montaggio:	Anteriore SX
Sistema:	A doppio tubo
Tipologia:	A pressione del gas
Fissaggio Superiore:	SPINA
Fissaggio Inferiore:	COLLARE
Diametro Corpo:	50
Diametro Stelo:	22
Interasse Boccole:	
Note:	

ABA4057

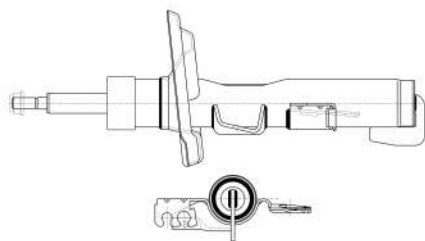

ABA4058

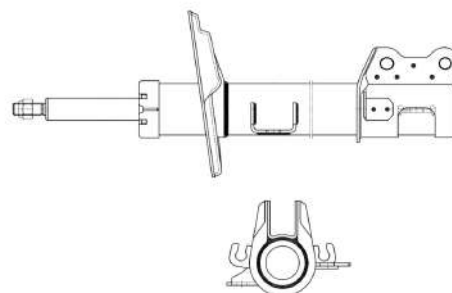

Caratteristiche	
Zona di montaggio:	Anteriore DX
Sistema:	A doppio tubo
Tipologia:	A pressione del gas
Fissaggio Superiore:	SPINA
Fissaggio Inferiore:	COLLARE
Diametro Corpo:	50
Diametro Stelo:	22
Interasse Boccole:	
Note:	

Caratteristiche	
Zona di montaggio:	Anteriore DX
Sistema:	A doppio tubo
Tipologia:	A pressione del gas
Fissaggio Superiore:	SPINA
Fissaggio Inferiore:	STAFFA
Diametro Corpo:	51
Diametro Stelo:	22
Interasse Boccole:	
Note:	

ABA4059

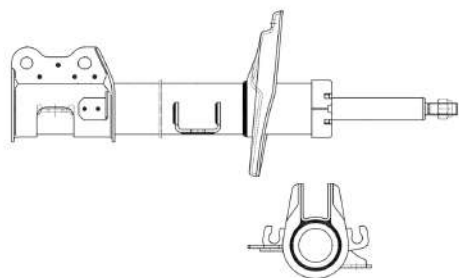

ABA4060

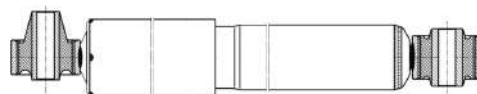

Caratteristiche	
Zona di montaggio:	Anteriore SX
Sistema:	A doppio tubo
Tipologia:	A pressione del gas
Fissaggio Superiore:	SPINA
Fissaggio Inferiore:	STAFFA
Diametro Corpo:	51
Diametro Stelo:	22
Interasse Boccole:	
Note:	

Caratteristiche	
Zona di montaggio:	Posteriore
Sistema:	A doppio tubo
Tipologia:	A pressione del gas
Fissaggio Superiore:	OCCHIELLO
Fissaggio Inferiore:	OCCHIELLO
Diametro Corpo:	45
Diametro Stelo:	12,5
Interasse Boccole:	40-48
Note:	

ABA4061

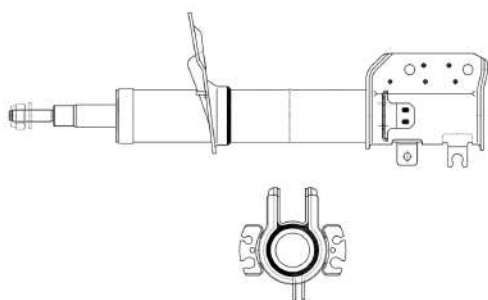

ABA4062

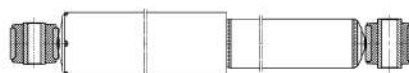

Caratteristiche	
Zona di montaggio:	Anteriore
Sistema:	A doppio tubo
Tipologia:	A pressione del gas
Fissaggio Superiore:	SPINA
Fissaggio Inferiore:	STAFFA
Diametro Corpo:	52
Diametro Stelo:	22
Interasse Boccole:	
Note:	

Caratteristiche	
Zona di montaggio:	Posteriore
Sistema:	A doppio tubo
Tipologia:	A pressione del gas
Fissaggio Superiore:	OCCHIELLO
Fissaggio Inferiore:	OCCHIELLO
Diametro Corpo:	38
Diametro Stelo:	12,5
Interasse Boccole:	32-38
Note:	

ABA4063

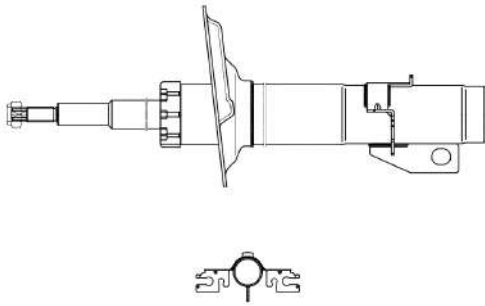

ABA4064

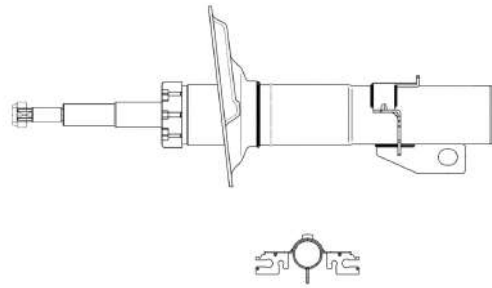

Caratteristiche	
Zona di montaggio:	Anteriore
Sistema:	A doppio tubo
Tipologia:	A pressione del gas
Fissaggio Superiore:	SPINA
Fissaggio Inferiore:	STAFFA
Diametro Corpo:	60
Diametro Stelo:	28
Interasse Boccole:	
Note:	Allestimento Pesante

Caratteristiche	
Zona di montaggio:	Anteriore
Sistema:	A doppio tubo
Tipologia:	A pressione del gas
Fissaggio Superiore:	SPINA
Fissaggio Inferiore:	STAFFA
Diametro Corpo:	60
Diametro Stelo:	25
Interasse Boccole:	
Note:	Allestimento Leggero

ABA4065

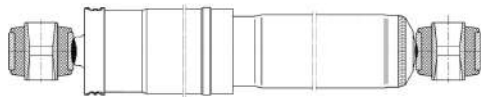

ABA4066

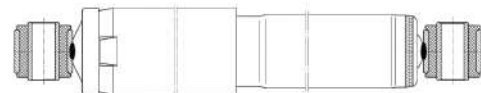

Caratteristiche	
Zona di montaggio:	Posteriore
Sistema:	A doppio tubo
Tipologia:	A pressione del gas
Fissaggio Superiore:	OCCHIELLO
Fissaggio Inferiore:	OCCHIELLO
Diametro Corpo:	51
Diametro Stelo:	15
Interasse Boccole:	40
Note:	Lunghezza MAX. 465

Caratteristiche	
Zona di montaggio:	Posteriore
Sistema:	A doppio tubo
Tipologia:	A pressione del gas
Fissaggio Superiore:	OCCHIELLO
Fissaggio Inferiore:	OCCHIELLO
Diametro Corpo:	51
Diametro Stelo:	15
Interasse Boccole:	40
Note:	Lunghezza MAX. 438

ABA4067

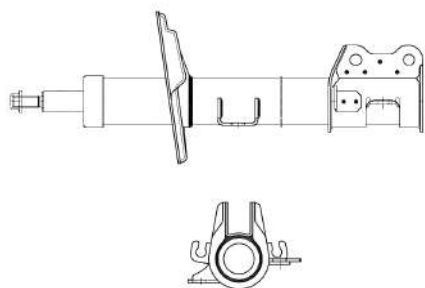

ABA4068

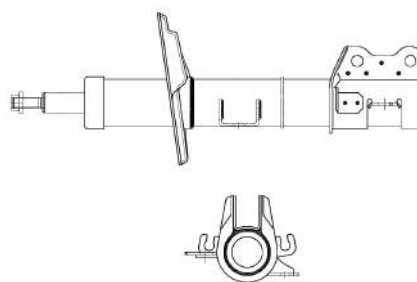

Caratteristiche	
Zona di montaggio:	Anteriore DX
Sistema:	A doppio tubo
Tipologia:	A pressione del gas
Fissaggio Superiore:	SPINA
Fissaggio Inferiore:	STAFFA
Diametro Corpo:	49
Diametro Stelo:	22
Interasse Boccole:	
Note:	

Caratteristiche	
Zona di montaggio:	Anteriore SX
Sistema:	A doppio tubo
Tipologia:	A pressione del gas
Fissaggio Superiore:	SPINA
Fissaggio Inferiore:	STAFFA
Diametro Corpo:	49
Diametro Stelo:	22
Interasse Boccole:	
Note:	

ABA4069

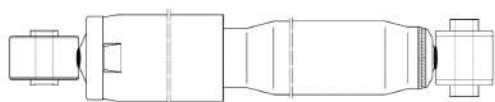

ABA4070

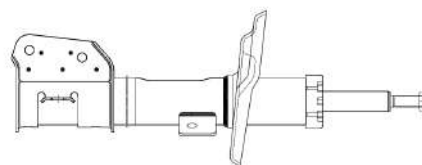

Caratteristiche	
Zona di montaggio:	Posteriore
Sistema:	A doppio tubo
Tipologia:	A pressione del gas
Fissaggio Superiore:	OCCHIELLO
Fissaggio Inferiore:	OCCHIELLO
Diametro Corpo:	51
Diametro Stelo:	12,5
Interasse Boccole:	38-52
Note:	

Caratteristiche	
Zona di montaggio:	Anteriore
Sistema:	A doppio tubo
Tipologia:	A pressione del gas
Fissaggio Superiore:	SPINA
Fissaggio Inferiore:	STAFFA
Diametro Corpo:	51
Diametro Stelo:	22
Interasse Boccole:	
Note:	

ABA4071

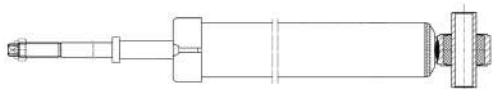

ABA4072

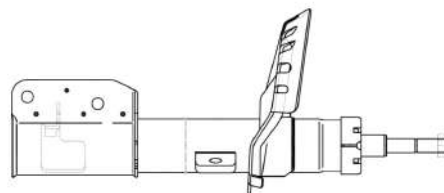

Caratteristiche	
Zona di montaggio:	Posteriore
Sistema:	A doppio tubo
Tipologia:	A pressione del gas
Fissaggio Superiore:	SPINA
Fissaggio Inferiore:	OCCHIELLO
Diametro Corpo:	38
Diametro Stelo:	12,5
Interasse Boccole:	52
Note:	

Caratteristiche	
Zona di montaggio:	Anteriore DX
Sistema:	A doppio tubo
Tipologia:	A pressione del gas
Fissaggio Superiore:	SPINA
Fissaggio Inferiore:	STAFFA
Diametro Corpo:	54
Diametro Stelo:	22
Interasse Boccole:	
Note:	

ABA4073

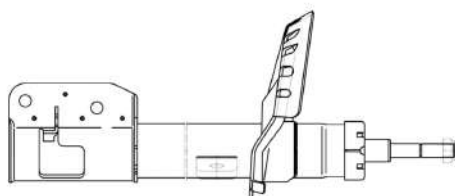

ABA4074



Caratteristiche	
Zona di montaggio:	Anteriore SX
Sistema:	A doppio tubo
Tipologia:	A pressione del gas
Fissaggio Superiore:	SPINA
Fissaggio Inferiore:	STAFFA
Diametro Corpo:	54
Diametro Stelo:	22
Interasse Boccole:	
Note:	

Caratteristiche	
Zona di montaggio:	Posteriore
Sistema:	A doppio tubo
Tipologia:	A pressione del gas
Fissaggio Superiore:	OCCHIELLO
Fissaggio Inferiore:	OCCHIELLO
Diametro Corpo:	45
Diametro Stelo:	15
Interasse Boccole:	45
Note:	

ABA4075

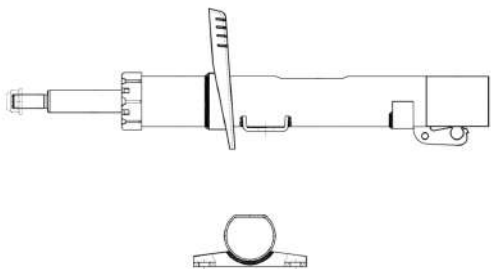

ABA4076

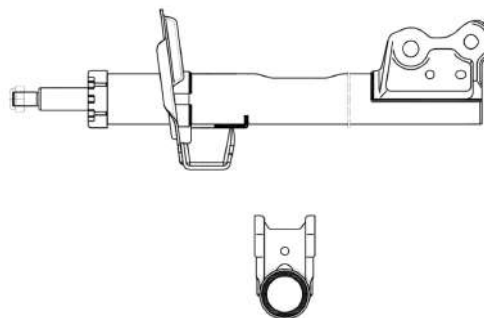

Caratteristiche	
Zona di montaggio:	Anteriore
Sistema:	A doppio tubo
Tipologia:	A pressione del gas
Fissaggio Superiore:	SPINA
Fissaggio Inferiore:	COLLARE
Diametro Corpo:	50
Diametro Stelo:	22
Interasse Boccole:	
Note:	

Caratteristiche	
Zona di montaggio:	Anteriore
Sistema:	A doppio tubo
Tipologia:	A pressione del gas
Fissaggio Superiore:	SPINA
Fissaggio Inferiore:	STAFFA
Diametro Corpo:	50
Diametro Stelo:	22
Interasse Boccole:	
Note:	

ABA4077

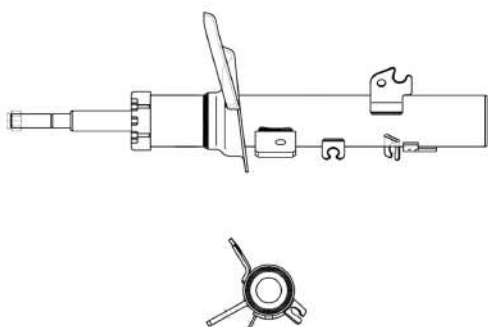

ABA4078

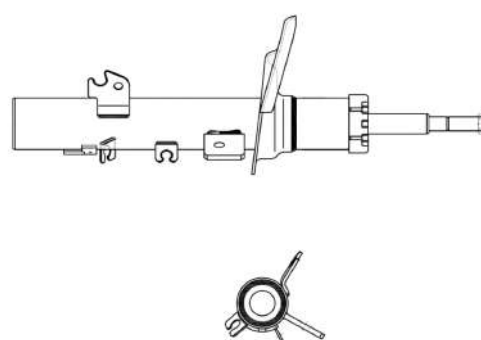

Caratteristiche	
Zona di montaggio:	Anteriore DX
Sistema:	A doppio tubo
Tipologia:	A pressione del gas
Fissaggio Superiore:	SPINA
Fissaggio Inferiore:	COLLARE
Diametro Corpo:	51
Diametro Stelo:	20
Interasse Boccole:	
Note:	

Caratteristiche	
Zona di montaggio:	Anteriore SX
Sistema:	A doppio tubo
Tipologia:	A pressione del gas
Fissaggio Superiore:	SPINA
Fissaggio Inferiore:	COLLARE
Diametro Corpo:	51
Diametro Stelo:	20
Interasse Boccole:	
Note:	

DETTAGLIO PRODOTTI - AMMORTIZZATORI

PRODUCT DETAILS - SHOCK ABSORBERS

DETAILS PRODUITS - AMORTISSEURS



ABR5000		Posizione:	Anteriore	ABR5001		Posizione:	Posteriore
Cross AM		Cross OE		Cross AM		Cross OE	
BIRTH	59027	VAG	1K0412249B	BIRTH	51093	VAG	1K0513353G
JAPANPARTS	SM0148	VAG	6N0412331D	JAPANPARTS	SM0334		
KYB	SM1714			KYB	SM9707		
MONROE	MK156			MONROE	MK203		
UNIGOM	391190C			UNIGOM	391196		
Applicabile a:	ABA4000, ABA4011			Applicabile a:	ABA4001		

ABR5002		Posizione:	Anteriore	ABR5003		Posizione:	Posteriore DX
Cross AM		Cross OE		Cross AM		Cross OE	
BIRTH	50958	FCA	50510134	BIRTH	50913	FCA	51803172
JAPANPARTS	SM0149	FCA	51780079	JAPANPARTS	SM0165	FCA	55701901
KYB	SM1036	FCA	51813225	KYB	SM9805	OPEL	436774
MONROE	MK305	FCA	51831016	MONROE	MK384R	OPEL	55703318
UNIGOM	390290	FCA	52027765	UNIGOM	390296		
Applicabile a:	ABA4002, ABA4003, ABA4018, ABA4019, ABA4052, ABA4053			Applicabile a:	ABA4004		

ABR5004		Posizione:	Posteriore	ABR5005		Posizione:	Anteriore
Cross AM		Cross OE		Cross AM		Cross OE	
BIRTH	51773	FORD	1535299	BIRTH	51771 + 6421	FORD	1526778
JAPANPARTS	SM0140	MAZDA	DF712870XC	JAPANPARTS	SM0139	FORD	1514857
KYB	SM5802	MAZDA	DR612870X	KYB	SM1550	FORD	1689147
MONROE	MK364	MAZDA	DR612870XD	MONROE	MK317	MAZDA	D65134380B
UNIGOM	392426			UNIGOM	392420C / 392470C	MAZDA	D6513438XA
Applicabile a:	ABA4005			Applicabile a:	ABA4006, ABA4007, ABA4025, ABA4026		

ABR5006		Posizione:	Anteriore	ABR5007		Posizione:	Anteriore
Cross AM		Cross OE		Cross AM		Cross OE	
BIRTH	50115	FCA	46746544	BIRTH	59038	PSA	5031C2
JAPANPARTS	SM0137	FCA	51830518	JAPANPARTS	SM0396	PSA	503557
KYB	SM1810	FCA	50706933	KYB	SM1930	PSA	5038F6
MONROE	MK095	FIAT	51876262	MONROE	MK351	TOYOTA	486090H010
UNIGOM	390232	FORD	1619751	UNIGOM	391232	TOYOTA	486190H010
Applicabile a:	ABA4016, ABA4017, ABA4020, ABA4021, ABA4034, ABA4040, ABA4041			Applicabile a:	ABA4012, ABA4013		

ABR5008		Posizione:	Anteriore	ABR5009		Posizione:	Anteriore
Cross AM		Cross OE		Cross AM		Cross OE	
BIRTH	5088	FCA	4400895	BIRTH	59192	PSA	1638380680
JAPANPARTS	SM0325	FCA	7635775	JAPANPARTS	SM0153	PSA	5031F2
KYB	SM1804	VAG	SE141156228A	KYB	SM1553	PSA	5038G6
MONROE	MK029			MONROE	MK321 + MK001	PSA	5038H4
UNIGOM	390027			UNIGOM	391272C	OPEL	3637222
Applicabile a:	ABA4020, ABA4021, ABA4022			Applicabile a:	ABA4027, ABA4028, ABA4029, ABA4030		

ABR5010		Posizione:	Anteriore DX	ABR5011		Posizione:	Anteriore
Cross AM		Cross OE		Cross AM		Cross OE	
BIRTH	59066	RENAULT	7701208591	BIRTH	59003	VAG	1J0412249
JAPANPARTS	SM0053	RENAULT	7701208823	JAPANPARTS	SM0144	VAG	1J0412331C
KYB	SM2806 / SM1527	RENAULT	8200183568	KYB	SM1704	VAG	357412331AS
MONROE	MK263R	RENAULT	8200504295	MONROE	MK077	VAG	6R0412249
UNIGOM	392730C	NISSAN	54320BC40A	UNIGOM	391168C		
Applicabile a:	ABA4038			Applicabile a:	ABA4039		

ABR5012		Posizione:	Anteriore	ABR5013		Posizione:	Anteriore
Cross AM		Cross OE		Cross AM		Cross OE	
BIRTH	51112	MERCEDES	A1693200073	BIRTH	59245	TOYOTA	486090D040
JAPANPARTS	-	MERCEDES	A169320007328	JAPANPARTS	SM0004	TOYOTA	4860952100
KYB	SM5785			KYB	SM5641	TOYOTA	486190D011
MONROE	MK378			MONROE	MK387	TOYOTA	4861952040
UNIGOM	391694			UNIGOM	392950C		
Applicabile a:	ABA4043			Applicabile a:	ABA4044, ABA4045		

ABR5014		Posizione:	Anteriore	ABR5015		Posizione:	Posteriore
Cross AM		Cross OE		Cross AM		Cross OE	
BIRTH	50647	MERCEDES	A4513220028	BIRTH	53602	BMW	33526768544
JAPANPARTS	SM0477			JAPANPARTS	12-251179		
KYB	SM5674			KYB	-		
MONROE	MK396			MONROE	MK444		
UNIGOM	391690			UNIGOM	391385		
Applicabile a:	ABA4048			Applicabile a:	ABA4049		

ABR5016		Posizione:	Anteriore	ABR5017		Posizione:	Posteriore
Cross AM		Cross OE		Cross AM		Cross OE	
BIRTH	50129 / 51956	BMW	31306775098	BIRTH	53189	VAG	1J0513353D
JAPANPARTS	SM0174	BMW	31352298910	JAPANPARTS	SM0132		
KYB	SM1003	BMW	31336770568	KYB	SM9703		
MONROE	MK136 / MK163	BMW	31336769582	MONROE	MK118		
UNIGOM	391353 / 391353	BMW	31336760943	UNIGOM	391882		
Applicabile a:	ABA4050, ABA4051			Applicabile a:	ABA4054		
ABR5018		Posizione:	Anteriore SX	ABR5019		Posizione:	Anteriore DX
Cross AM		Cross OE		Cross AM		Cross OE	
BIRTH	52015	FCA	50520155	BIRTH	52014	FCA	50520154
JAPANPARTS	SM0258			JAPANPARTS	SM0259		
KYB	-			KYB	-		
MONROE	MK474L			MONROE	MK473R		
UNIGOM	392101			UNIGOM	392100		
Applicabile a:	ABA4056			Applicabile a:	ABA4057		
ABR5020		Posizione:	Posteriore SX	ABR5021		Posizione:	Anteriore SX
Cross AM		Cross OE		Cross AM		Cross OE	
BIRTH	50912	FCA	51803173	BIRTH	59067	RENAULT	7701208582
JAPANPARTS	SM0166	FCA	55701902	JAPANPARTS	SM0054	RENAULT	7701208822
KYB	SM9806	OPEL	436773	KYB	SM2805 / SM1526	RENAULT	8200183567
MONROE	MK385L	OPEL	55703317	MONROE	MK264L	RENAULT	8200504291
UNIGOM	390297			UNIGOM	392731C	NISSAN	54321BC40A
Applicabile a:	ABA4004			Applicabile a:	ABA4038		
ABR5022		Posizione:	Posteriore	ABS5600		Posizione:	Anteriore
Cross AM		Cross OE		Cross AM		Cross OE	
BIRTH	52511	BMW	33506771737	BIRTH	5019	MERCEDES	A4513230292
JAPANPARTS	-	BMW	33506771738	UNIGOM	391698		
KYB	SM5752			Altezza	170		
MONROE	MK379			Diametro 1	18,5		
UNIGOM	391389K			Diametro 2	52		
Applicabile a:	ABA4049			Applicabile a:	ABA4048		

ABS5601		Posizione:	Anteriore	ABS5602		Posizione:	Anteriore
Cross AM		Cross OE		Cross AM		Cross OE	
BIRTH	5080	VAG	SE141156212A	BIRTH	50092	FCA	50520826
UNIGOM	390026	FCA	4409263	UNIGOM	392103		
Altezza	185			Altezza	210		
Diametro 1	20			Diametro 1	21		
Diametro 2	62			Diametro 2	69		
Applicabile a:	ABA4020, ABA4021, ABA4022			Applicabile a:	ABA4056, ABA4057		

ABS5603		Posizione:	Anteriore	ABS5604		Posizione:	Anteriore
Cross AM		Cross OE		Cross AM		Cross OE	
BIRTH	50118	FCA	46531017	BIRTH	50293	VAG	357413175A
UNIGOM	390233			UNIGOM	391809		
Altezza	212			Altezza	215		
Diametro 1	22,7			Diametro 1	22		
Diametro 2	58			Diametro 2	59		
Applicabile a:	ABA4034			Applicabile a:	ABA4039		

ABS5605		Posizione:	Anteriore	ABS5606		Posizione:	Anteriore
Cross AM		Cross OE		Cross AM		Cross OE	
BIRTH	50303	BMW	31331094749	BIRTH	50320	VAG	6N0413175A
UNIGOM	391377			UNIGOM	391192		
Altezza	124			Altezza	195		
Diametro 1	60			Diametro 1	65		
Diametro 2	70			Diametro 2	74		
Applicabile a:	ABA4050, ABA4051			Applicabile a:	ABA4000, ABA4011		

ABS5607		Posizione:	Posteriore	ABS5608		Posizione:	Anteriore
Cross AM		Cross OE		Cross AM		Cross OE	
BIRTH	50944	FCA	55701429	BIRTH	51113	MERCEDES	A1693230192
UNIGOM	390298	OPEL	13237297	UNIGOM	391693	MERCEDES	A169323019228
Altezza	286			Altezza	210		
Diametro 1	20			Diametro 1	20		
Diametro 2	61			Diametro 2	63		
Applicabile a:	ABA4004			Applicabile a:	ABA4043		

ABS5609		Posizione:	Anteriore	ABS5610		Posizione:	Anteriore
Cross AM		Cross OE		Cross AM		Cross OE	
BIRTH	51119	FCA	50703131	BIRTH	51121	FCA	7637083
UNIGOM	390245	FCA	50704937	UNIGOM	390158		
Altezza	250	FCA	51856852	Altezza	110		
Diametro 1	22,5	FCA	51856855	Diametro 1	42		
Diametro 2	64			Diametro 2	62		
Applicabile a:	ABA4040, ABA4041			Applicabile a:	ABA4036		

ABS5611		Posizione:	Anteriore	ABS5612		Posizione:	Anteriore
Cross AM		Cross OE		Cross AM		Cross OE	
BIRTH	51123	PSA	525448	BIRTH	51124	PSA	503198
UNIGOM	392201	PSA	525439	UNIGOM	391234		
Altezza	190	OPEL	3637220	Altezza	200		
Diametro 1	34	OPEL	525448	Diametro 1	57		
Diametro 2	53			Diametro 2	62		
Applicabile a:	ABA4027, ABA4028, ABA4029, ABA4030			Applicabile a:	ABA4012, ABA4013		

ABS5613		Posizione:	Anteriore	ABS5614		Posizione:	Anteriore
Cross AM		Cross OE		Cross AM		Cross OE	
BIRTH	51419	FCA	51755686	BIRTH	51755	FCA	52063730
UNIGOM	390293	FCA	55700767	UNIGOM	390263	FCA	52063729
Altezza	200	PSA	525447	Altezza	205	FCA	51856854
Diametro 1	66	OPEL	24413026	Diametro 1	22,5	FORD	1639562
Diametro 2	80	OPEL	9231099	Diametro 2	64		
Applicabile a:	ABA4002, ABA4003, ABA4018, ABA4019, ABA4052, ABA4053			Applicabile a:	ABA4016, ABA4017, ABA4020, ABA4021		

ABS5615		Posizione:	Anteriore	ABS5616		Posizione:	Anteriore
Cross AM		Cross OE		Cross AM		Cross OE	
BIRTH	51775	FORD	1514543	BIRTH	52623	RENAULT	543884315R
UNIGOM	392422	FORD	1750640	UNIGOM	392736	RENAULT	543889524R
Altezza	230			Altezza	210		
Diametro 1	57			Diametro 1	62		
Diametro 2	79			Diametro 2	76		
Applicabile a:	ABA4006, ABA4007, ABA4025, ABA4026			Applicabile a:	ABA4038		

ABS5617		Posizione:	Posteriore	ABS5618		Posizione:	Anteriore
Cross AM		Cross OE		Cross AM		Cross OE	
BIRTH	54359	FORD	1776922	BIRTH	-	TOYOTA	481570D050
UNIGOM	393417			UNIGOM	392951	TOYOTA	4815752030
Altezza	200			Altezza	197	TOYOTA	4833152080
Diametro 1	34			Diametro 1	63		
Diametro 2	47			Diametro 2	84		
Applicabile a:	ABA4005			Applicabile a:	ABA4044, ABA4045		

ABT5300		Posizione:	Anteriore	ABT5301		Posizione:	Anteriore
Cross AM		Cross OE		Cross AM		Cross OE	
BIRTH	50258	VAG	1H0412303B	BIRTH	50302	BMW	31331094750
UNIGOM	391170			UNIGOM	391375		
Altezza	64			Altezza	87		
Diametro 1	18/22			Diametro 1	18		
Diametro 2	50			Diametro 2	28		
Applicabile a:	ABA4039			Applicabile a:	ABA4050, ABA4051		

ABT5302		Posizione:	Anteriore	ABT5303		Posizione:	Anteriore
Cross AM		Cross OE		Cross AM		Cross OE	
BIRTH	50326	VAG	357412303F	BIRTH	50887	FCA	46412047
UNIGOM	391807			UNIGOM	390169		
Altezza	84			Altezza	86		
Diametro 1	18			Diametro 1	16		
Diametro 2	26			Diametro 2	23		
Applicabile a:	ABA4039			Applicabile a:	ABA4036		

ABT5304		Posizione:	Anteriore	ABT5305		Posizione:	Anteriore
Cross AM		Cross OE		Cross AM		Cross OE	
BIRTH	50947	FCA	51866009	BIRTH	50966	VAG	1K0412303M
UNIGOM	390292	FCA	51885856	UNIGOM	392843		
Altezza	65	PSA	5033F2	Altezza	86		
Diametro 1	20	OPEL	13197623	Diametro 1	22		
Diametro 2	27			Diametro 2	27		
Applicabile a:	ABA4002, ABA4003, ABA4018, ABA4019, ABA4052, ABA4053			Applicabile a:	ABA4000		

ABT5306		Posizione:	Posteriore	ABT5307		Posizione:	Posteriore
Cross AM		Cross OE		Cross AM		Cross OE	
BIRTH	50973	VAG	1K0511353M	BIRTH	50979	VAG	6Q0512131B
UNIGOM	392834			UNIGOM	392835		
Altezza	132			Altezza	124		
Diametro 1	15			Diametro 1	15		
Diametro 2	18			Diametro 2	17		
Applicabile a:	ABA4001			Applicabile a:	ABA4054		

ABT5308		Posizione:	Anteriore	ABT5309		Posizione:	Posteriore
Cross AM		Cross OE		Cross AM		Cross OE	
BIRTH	50995	VAG	1K0412303B	BIRTH	50996	VAG	1K0511353J
UNIGOM	391191	VAG	1KD412303	UNIGOM	392816		
Altezza	72			Altezza	100		
Diametro 1	22			Diametro 1	18		
Diametro 2	26			Diametro 2	56		
Applicabile a:	ABA4000, ABA4011			Applicabile a:	ABA4001		

ABT5310		Posizione:	Anteriore	ABT5311		Posizione:	Posteriore
Cross AM		Cross OE		Cross AM		Cross OE	
BIRTH	51131	PSA	503396	BIRTH	51834	VAG	3C0511359
UNIGOM	391233			UNIGOM	393809		
Altezza	97			Altezza	135		
Diametro 1	14			Diametro 1	17		
Diametro 2	22			Diametro 2	57		
Applicabile a:	ABA4012, ABA4013			Applicabile a:	ABA4001		

ABT5312		Posizione:	Posteriore	ABT5313		Posizione:	Posteriore
Cross AM		Cross OE		Cross AM		Cross OE	
BIRTH	51903	VAG	1K0511353Q	BIRTH	52494	VAG	7N0511359A
UNIGOM	392826			UNIGOM	-		
Altezza	104			Altezza	135		
Diametro 1	15			Diametro 1	16		
Diametro 2	16,5			Diametro 2	18		
Applicabile a:	ABA4001			Applicabile a:	ABA4001		

ABT5314		Posizione:	Anteriore	ABT5315		Posizione:	Anteriore
Cross AM		Cross OE		Cross AM		Cross OE	
BIRTH	52708	RENAULT	540500558R	BIRTH	54337	PSA	9676408280
UNIGOM	-			UNIGOM	391273	PSA	5033E3
Altezza	73			Altezza	86		
Diametro 1	18-24			Diametro 1	22		
Diametro 2	56			Diametro 2	-		
Applicabile a:	ABA4038			Applicabile a:	ABA4027, ABA4028, ABA4029, ABA4030		

ABT5316		Posizione:	Posteriore	ABT5317		Posizione:	Posteriore
Cross AM		Cross OE		Cross AM		Cross OE	
BIRTH	54281	FORD	1792629	BIRTH	54378	FORD	1780533
UNIGOM	392421/1			UNIGOM	393416		
Altezza	75			Altezza	134		
Diametro 1	18			Diametro 1	13		
Diametro 2	25			Diametro 2	16		
Applicabile a:	ABA4006, ABA4007, ABA4025, ABA4026			Applicabile a:	ABA4005		

ABR5000



ABR5001



ABR5002



ABR5003



ABR5004



ABR5005



ABR5006



ABR5007



ABR5008



ABR5009



ABR5010



ABR5011



ABR5012



ABR5013



ABR5014



ABR5015



ABR5016



ABR5017



ABR5018



ABR5019



ABR5020



ABR5021



ABR5022



ABS5600

CORRISPONDENZE

CROSS REFERENCE
CORRESPONDANCES



AP XENERGY	X005348	ABA4033	AP XENERGY	X807332	ABA4013	ARTFIX	IFSS149	ABA4042	ASHIKA	MA-00499	ABA4054
AP XENERGY	X019349	ABA4024	AP XENERGY	X808332	ABA4012	ARTFIX	IFSS151	ABA4038	ASHIKA	MA00525	ABA4039
AP XENERGY	X041349	ABA4049	AP XENERGY	X808335	ABA4011	ARTFIX	IFSS161	ABA4039	ASHIKA	MA-00552	ABA4063
AP XENERGY	X077441	ABA4023	AP XENERGY	X808339	ABA4067	ARTFIX	IFSS164	ABA4047	ASHIKA	MA00577	ABA4022
AP XENERGY	X078345	ABA4074	AP XENERGY	X808343	ABA4014	ARTFIX	IFSS167	ABA4013	ASHIKA	MA00606	ABA4040
AP XENERGY	X079345	ABA4074	AP XENERGY	X809339	ABA4068	ARTFIX	IFSS168	ABA4012	ASHIKA	MA00608	ABA4040
AP XENERGY	X098441	ABA4032	AP XENERGY	X810344	ABA4042	ARTFIX	IFSS169	ABA4014	ASHIKA	MA00609	ABA4041
AP XENERGY	X145349	ABA4069	AP XENERGY	X823343	ABA4046	ARTFIX	IFSS175	ABA4046	ASHIKA	MA00612	ABA4023
AP XENERGY	X148349	ABA4060	AP XENERGY	X826343	ABA4071	ARTFIX	IFSS178	ABA4001	ASHIKA	MA00629	ABA4042
AP XENERGY	X149349	ABA4060	AP XENERGY	X827335	ABA4064	ARTFIX	IFSS179	ABA4011	ASHIKA	MA00633	ABA4024
AP XENERGY	X189341	ABA4032	AP XENERGY	X828343	ABA4035	ARTFIX	IFSS184	ABA4054	ASHIKA	MA-00637	ABA4069
AP XENERGY	X328343	ABA4054	AP XENERGY	X834334	ABA4000	ARTFIX	IFSS188	ABA4012	ASHIKA	MA-00661	ABA4060
AP XENERGY	X340553	ABA4037	AP XENERGY	X835334	ABA4075	ARTFIX	IFSS189	ABA4013	ASHIKA	MA-00664	ABA4059
AP XENERGY	X393553	ABA4047	AP XENERGY	X850339	ABA4056	ARTFIX	IFSS217	ABA4050	ASHIKA	MA-00665	ABA4058
AP XENERGY	X397343	ABA4071	AP XENERGY	X851339	ABA4057	ARTFIX	IFSS218	ABA4051	ASHIKA	MA00672	ABA4038
AP XENERGY	X415343	ABA4008	AP XENERGY	X852339	ABA4043	ARTFIX	IFSS257	ABA4037	ASHIKA	MA00688	ABA4022
AP XENERGY	X459343	ABA4004	AP XENERGY	X853339	ABA4076	ARTFIX	IFSS258	ABA4049	ASHIKA	MA00689	ABA4023
AP XENERGY	X459344	ABA4001	AP XENERGY	X864334	ABA4034	ARTFIX	IFSS259	ABA4044	ASHIKA	MA-00691	ABA4064
AP XENERGY	X488343	ABA4015	AP XENERGY	X870333	ABA4036	ARTFIX	IFSS260	ABA4045	ASHIKA	MA-00692	ABA4066
AP XENERGY	X625334	ABA4051	AP XENERGY	X951333	ABA4022	ARTFIX	IFSS271	ABA4056	ASHIKA	MA-00693	ABA4060
AP XENERGY	X626334	ABA4050	AP XENERGY	X951633	ABA4022	ARTFIX	IFSS272	ABA4057	ASHIKA	MA-00711	ABA4074
AP XENERGY	X665344	ABA4055	AP XENERGY	X997104	ABA4048	ARTFIX	IFSS294	ABA4024	ASHIKA	MA-00712	ABA4077
AP XENERGY	X700345	ABA4065	AP XENERGY	X998221	ABA4029	ARTFIX	IFSS347	ABA4066	ASHIKA	MA-00715	ABA4072
AP XENERGY	X700552	ABA4054	AP XENERGY	X998222	ABA4030	ARTFIX	IFSS361	ABA4072	ASHIKA	MA-00716	ABA4073
AP XENERGY	X701345	ABA4066	ARTFIX	IFSS003	ABA4055	ARTFIX	IFSS362	ABA4073	ASHIKA	MA00731	ABA4002
AP XENERGY	X707339	ABA4077	ARTFIX	IFSS010	ABA4075	ASHIKA	MA-00029	ABA4075	ASHIKA	MA-00734	ABA4065
AP XENERGY	X708339	ABA4078	ARTFIX	IFSS032	ABA4015	ASHIKA	MA00030	ABA4054	ASHIKA	MA-00755	ABA4078
AP XENERGY	X717339	ABA4053	ARTFIX	IFSS033	ABA4017	ASHIKA	MA00031	ABA4011	ASHIKA	MA-00760	ABA4071
AP XENERGY	X731338	ABA4025	ARTFIX	IFSS034	ABA4016	ASHIKA	MA00057	ABA4049	ASHIKA	MA-00763	ABA4078
AP XENERGY	X731339	ABA4070	ARTFIX	IFSS036	ABA4070	ASHIKA	MA00058	ABA4050	ASHIKA	MA00767	ABA4043
AP XENERGY	X732338	ABA4026	ARTFIX	IFSS039	ABA4058	ASHIKA	MA00059	ABA4051	ASHIKA	MA00770	ABA4005
AP XENERGY	X732339	ABA4070	ARTFIX	IFSS040	ABA4059	ASHIKA	MA00119	ABA4012	ASHIKA	MA00822	ABA4019
AP XENERGY	X737339	ABA4040	ARTFIX	IFSS041	ABA4060	ASHIKA	MA00120	ABA4013	ASHIKA	MA00822	ABA4052
AP XENERGY	X738339	ABA4041	ARTFIX	IFSS046	ABA4063	ASHIKA	MA00121	ABA4014	ASHIKA	MA00823	ABA4018
AP XENERGY	X739339	ABA4040	ARTFIX	IFSS047	ABA4064	ASHIKA	MA-00142	ABA4068	ASHIKA	MA00823	ABA4053
AP XENERGY	X741339	ABA4039	ARTFIX	IFSS049	ABA4067	ASHIKA	MA-00143	ABA4067	ASHIKA	MA00828	ABA4056
AP XENERGY	X744333	ABA4038	ARTFIX	IFSS050	ABA4068	ASHIKA	MA00160	ABA4015	ASHIKA	MA00829	ABA4057
AP XENERGY	X744633	ABA4038	ARTFIX	IFSS051	ABA4052	ASHIKA	MA00161	ABA4016	ASHIKA	MA00831	ABA4025
AP XENERGY	X763333	ABA4021	ARTFIX	IFSS053	ABA4004	ASHIKA	MA00162	ABA4017	ASHIKA	MA00832	ABA4026
AP XENERGY	X763339	ABA4039	ARTFIX	IFSS060	ABA4008	ASHIKA	MA-00163	ABA4070	ASHIKA	MA-00903	ABA4074
AP XENERGY	X764333	ABA4020	ARTFIX	IFSS066	ABA4033	ASHIKA	MA00165	ABA4036	ASHIKA	MA-00915	ABA4070
AP XENERGY	X766333	ABA4017	ARTFIX	IFSS068	ABA4021	ASHIKA	MA00167	ABA4032	ASHIKA	MA00919	ABA4021
AP XENERGY	X767333	ABA4016	ARTFIX	IFSS069	ABA4020	ASHIKA	MA00168	ABA4032	ASHIKA	MA00920	ABA4020
AP XENERGY	X771339	ABA4072	ARTFIX	IFSS071	ABA4040	ASHIKA	MA00180	ABA4033	ASHIKA	MA00921	ABA4034
AP XENERGY	X772339	ABA4073	ARTFIX	IFSS072	ABA4041	ASHIKA	MA00181	ABA4020	ASHIKA	MA-00953	ABA4076
AP XENERGY	X776333	ABA4077	ARTFIX	IFSS073	ABA4023	ASHIKA	MA00182	ABA4021	ASHIKA	MA00976	ABA4027
AP XENERGY	X777333	ABA4078	ARTFIX	IFSS074	ABA4034	ASHIKA	MA00183	ABA4008	ASHIKA	MA00977	ABA4028
AP XENERGY	X788339	ABA4058	ARTFIX	IFSS079	ABA4069	ASHIKA	MA00186	ABA4034	ASHIKA	MA00978	ABA4029
AP XENERGY	X789339	ABA4059	ARTFIX	IFSS080	ABA4036	ASHIKA	MA00188	ABA4035	ASHIKA	MA00979	ABA4030
AP XENERGY	X8002343	ABA4005	ARTFIX	IFSS081	ABA4032	ASHIKA	MA00189	ABA4036	ASHIKA	MA-00987	ABA4074
AP XENERGY	X8003334	ABA4019	ARTFIX	IFSS084	ABA4071	ASHIKA	MA-00190	ABA4071	ASHIKA	MA01028	ABA4039
AP XENERGY	X8004334	ABA4018	ARTFIX	IFSS092	ABA4025	ASHIKA	MA-00193	ABA4071	ASHIKA	MA-01031	ABA4075
AP XENERGY	X8012333	ABA4029	ARTFIX	IFSS094	ABA4005	ASHIKA	MA00289	ABA4037	ASHIKA	MA01034	ABA4054
AP XENERGY	X8013333	ABA4030	ARTFIX	IFSS102	ABA4000	ASHIKA	MA-00371	ABA4078	ASHIKA	MA01082	ABA4006
AP XENERGY	X8014333	ABA4027	ARTFIX	IFSS105	ABA4076	ASHIKA	MA-00372	ABA4077	ASHIKA	MA01083	ABA4007
AP XENERGY	X8015333	ABA4028	ARTFIX	IFSS107	ABA4043	ASHIKA	MA00393	ABA4038	ASHIKA	MA22081	ABA4044
AP XENERGY	X8041334	ABA4006	ARTFIX	IFSS108	ABA4037	ASHIKA	MA00492	ABA4000	ASHIKA	MA22082	ABA4045
AP XENERGY	X8042334	ABA4007	ARTFIX	IFSS139	ABA4022	ASHIKA	MA00498	ABA4001	ASHIKA	MA22083	ABA4046

ASHIKA	MA50061	ABA4003	BBF REDLINE	39FO007	ABA4026	BILSTEIN	22139320	ABA4011	BILSTEIN	22-144270	ABA4051
ASHIKA	MA-50062	ABA4077	BBF REDLINE	39FO008	ABA4025	BILSTEIN	22144249	ABA4050	BILSTEIN	22-152749	ABA4050
ASHIKA	MA50063	ABA4052	BBF REDLINE	39FT005	ABA4021	BILSTEIN	22144263	ABA4051	BILSTEIN	22-152756	ABA4051
ASHIKA	MA50064	ABA4053	BBF REDLINE	39FT011	ABA4034	BILSTEIN	22145697	ABA4048	BILSTEIN	22-152770	ABA4050
ASHIKA	MASMA04	ABA4047	BBF REDLINE	39FT016	ABA4040	BILSTEIN	22146809	ABA4012	BILSTEIN	22-152787	ABA4051
ASHIKA	MASMA05	ABA4048	BBF REDLINE	39FT017	ABA4041	BILSTEIN	22146816	ABA4013	BILSTEIN	22-158475	ABA4053
ASHIKA	MA-W0004	ABA4004	BBF REDLINE	39FT018	ABA4032	BILSTEIN	22151056	ABA4011	BILSTEIN	22-183415	ABA4064
ASHIKA	MA-W0016	ABA4075	BBF REDLINE	39FT024	ABA4035	BILSTEIN	22151070	ABA4011	BILSTEIN	22-183705	ABA4039
ATECSO	AMT00102	ABA4034	BBF REDLINE	39FT028	ABA4033	BILSTEIN	22158475	ABA4018	BILSTEIN	22-183828	ABA4078
ATECSO	AMT00103	ABA4004	BBF REDLINE	39FT032	ABA4052	BILSTEIN	22158482	ABA4052	BILSTEIN	22-183835	ABA4077
ATECSO	AMT00104	ABA4033	BBF REDLINE	39FT033	ABA4053	BILSTEIN	22167071	ABA4038	BILSTEIN	22-184160	ABA4078
ATECSO	AMT00105	ABA4022	BBF REDLINE	39FT056	ABA4036	BILSTEIN	22183705	ABA4039	BILSTEIN	22-184177	ABA4077
ATECSO	AMT00107	ABA4036	BBF REDLINE	39ME007	ABA4043	BILSTEIN	22183712	ABA4000	BILSTEIN	22-189271	ABA4068
ATECSO	AMT00109	ABA4017	BBF REDLINE	39PE011	ABA4024	BILSTEIN	22183729	ABA4011	BILSTEIN	22-189288	ABA4067
ATECSO	AMT00110	ABA4016	BBF REDLINE	39PE015	ABA4028	BILSTEIN	22188632	ABA4025	BILSTEIN	22-196309	ABA4075
ATECSO	AMT00111	ABA4032	BBF REDLINE	39PE016	ABA4027	BILSTEIN	22188649	ABA4026	BILSTEIN	22-196682	ABA4063
ATECSO	AMT00113	ABA4021	BBF REDLINE	39RE001	ABA4038	BILSTEIN	22195302	ABA4056	BILSTEIN	22-196965	ABA4040
ATECSO	AMT00114	ABA4020	BBF REDLINE	39RE004	ABA4042	BILSTEIN	22196859	ABA4011	BILSTEIN	22-215505	ABA4021
ATECSO	AMT00115	ABA4023	BBF REDLINE	39TO066	ABA4013	BILSTEIN	22196934	ABA4041	BILSTEIN	22-215833	ABA4076
ATECSO	AMT00117	ABA4019	BBF REDLINE	39TO067	ABA4012	BILSTEIN	22196941	ABA4040	BILSTEIN	22-226556	ABA4070
ATECSO	AMT00118	ABA4053	BBF REDLINE	39TO068	ABA4014	BILSTEIN	22197351	ABA4016	BILSTEIN	22-227065	ABA4059
ATECSO	AMT00121	ABA4015	BBF REDLINE	39TO172	ABA4044	BILSTEIN	22197368	ABA4017	BILSTEIN	22-227072	ABA4058
ATECSO	AMT00125	ABA4036	BBF REDLINE	39TO173	ABA4045	BILSTEIN	22215482	ABA4020	BILSTEIN	22-325488	ABA4064
ATECSO	AMT00128	ABA4001	BBF REDLINE	39TO174	ABA4046	BILSTEIN	22215734	ABA4043	BILSTEIN	22-325525	ABA4063
ATECSO	AMT00133	ABA4040	BBF REDLINE	39VW002	ABA4054	BILSTEIN	22225214	ABA4030	BILSTEIN	23-325500	ABA4064
ATECSO	AMT00134	ABA4041	BBF REDLINE	39VW021	ABA4039	BILSTEIN	22225221	ABA4029	BILSTEIN	23-325531	ABA4063
ATECSO	AMT00136	ABA4071	BILSTEIN	19019833	ABA4023	BILSTEIN	22230676	ABA4045	BILSTEIN	24-104616	ABA4037
ATECSO	AMT00137	ABA4043	BILSTEIN	19028576	ABA4032	BILSTEIN	22231376	ABA4002	BILSTEIN	25-336078	ABA4066
ATECSO	AMT00140	ABA4075	BILSTEIN	19105369	ABA4035	BILSTEIN	22246455	ABA4012	BILSTEIN	26-325552	ABA4066
ATECSO	AMT00141	ABA4054	BILSTEIN	19106120	ABA4054	BILSTEIN	22257369	ABA4003	BMW MINI	31316782329	ABA4050
ATECSO	AMT00142	ABA4064	BILSTEIN	19109572	ABA4054	BILSTEIN	24104371	ABA4037	BMW MINI	31316783988	ABA4051
ATECSO	AMT00146	ABA4070	BILSTEIN	19109589	ABA4054	BILSTEIN	24110204	ABA4037	BMW MINI	31316783995	ABA4050
ATECSO	AMT00148	ABA4038	BILSTEIN	19127439	ABA4001	BILSTEIN	24110211	ABA4037	BMW MINI	31316785593	ABA4050
ATECSO	AMT00149	ABA4011	BILSTEIN	19135021	ABA4049	BILSTEIN	24123266	ABA4037	BMW MINI	31316786017	ABA4050
ATECSO	AMT00155	ABA4039	BILSTEIN	19135052	ABA4049	BILSTEIN	24126793	ABA4047	BMW MINI	31316786018	ABA4051
ATECSO	AMT00162	ABA4000	BILSTEIN	19136592	ABA4049	BILSTEIN	19-019390	ABA4023	BMW MINI	31316786026	ABA4051
ATECSO	AMT00163	ABA4042	BILSTEIN	19136622	ABA4049	BILSTEIN	19-103044	ABA4032	BMW MINI	31316786029	ABA4050
ATECSO	AMT00181	ABA4027	BILSTEIN	19139333	ABA4001	BILSTEIN	19-144238	ABA4049	BMW MINI	33504035261	ABA4049
ATECSO	AMT00182	ABA4028	BILSTEIN	19142265	ABA4008	BILSTEIN	19-152790	ABA4049	BMW MINI	33526768917	ABA4049
ATECSO	AMT00192	ABA4037	BILSTEIN	19144221	ABA4049	BILSTEIN	19-167060	ABA4042	BMW MINI	33526768921	ABA4049
ATECSO	AMT00193	ABA4065	BILSTEIN	19145266	ABA4049	BILSTEIN	19-171203	ABA4074	BMW MINI	33526771555	ABA4049
ATECSO	AMT00195	ABA4058	BILSTEIN	19147659	ABA4014	BILSTEIN	19-183398	ABA4065	BMW MINI	33526771725	ABA4049
ATECSO	AMT00196	ABA4059	BILSTEIN	19151069	ABA4001	BILSTEIN	19-189291	ABA4069	BMW MINI	33526771729	ABA4049
ATECSO	AMT00207	ABA4024	BILSTEIN	19151083	ABA4001	BILSTEIN	19-225289	ABA4074	BMW MINI	33526772916	ABA4049
ATECSO	AMT00222	ABA4047	BILSTEIN	19152769	ABA4049	BILSTEIN	19-226781	ABA4065	BMW MINI	33526772926	ABA4049
ATECSO	AMT00226	ABA4067	BILSTEIN	19158150	ABA4046	BILSTEIN	19-226798	ABA4066	BMW MINI	33526780077	ABA4049
ATECSO	AMT00227	ABA4068	BILSTEIN	19158495	ABA4004	BILSTEIN	19-227085	ABA4060	BMW MINI	33526780081	ABA4049
ATECSO	AMT00228	ABA4069	BILSTEIN	19158969	ABA4024	BILSTEIN	19-238791	ABA4071	BMW MINI	33526780195	ABA4049
ATECSO	AMT00255	ABA4072	BILSTEIN	19184104	ABA4015	BILSTEIN	19-313658	ABA4064	BMW MINI	33526782859	ABA4049
ATECSO	AMT00256	ABA4073	BILSTEIN	19197210	ABA4033	BILSTEIN	19-325491	ABA4065	BMW MINI	33526783989	ABA4049
ATECSO	AMT00266	ABA4008	BILSTEIN	19225234	ABA4024	BILSTEIN	19-325545	ABA4066	BMW MINI	33526783997	ABA4049
ATECSO	AMT00289	ABA4055	BILSTEIN	19239286	ABA4005	BILSTEIN	19-326986	ABA4065	BMW MINI	33526784977	ABA4049
ATECSO	AMT00290	ABA4057	BILSTEIN	19243122	ABA4024	BILSTEIN	22-040879	ABA4022	BMW MINI	33526796157	ABA4049
ATECSO	AMT00291	ABA4056	BILSTEIN	19246475	ABA4014	BILSTEIN	22-041210	ABA4022	BMW MINI	33526796161	ABA4049
ATECSO	AMT00305	ABA4039	BILSTEIN	22105349	ABA4034	BILSTEIN	22-044839	ABA4036	BMW MINI	33528036014	ABA4049
BBF REDLINE	39BW004	ABA4050	BILSTEIN	22131607	ABA4000	BILSTEIN	22-105356	ABA4034	BMW MINI	33528036026	ABA4049
BBF REDLINE	39BW005	ABA4051	BILSTEIN	22131614	ABA4011	BILSTEIN	22-105813	ABA4075	BOGE	279616	ABA4022
BBF REDLINE	39BW006	ABA4049	BILSTEIN	22139191	ABA4011	BILSTEIN	22-144256	ABA4050	BOGE	27-603-0	ABA4023

BOGE	27603A ABA4023	BOGE	32-B26-F ABA4036	BOGE	36K85A ABA4011	BREMSI	SA0641 ABA4071
BOGE	27-961-F ABA4022	BOGE	32F72F ABA4021	BREMSI	SA0017 ABA4075	BREMSI	SA0644 ABA4078
BOGE	27-A91-0 ABA4032	BOGE	32-H90-0 ABA4075	BREMSI	SA0018 ABA4054	BREMSI	SA0648 ABA4043
BOGE	27A91F ABA4032	BOGE	32-H90-F ABA4075	BREMSI	SA0019 ABA4011	BREMSI	SA0648 ABA4076
BOGE	27-D54-0 ABA4032	BOGE	32K67A ABA4049	BREMSI	SA0040 ABA4049	BREMSI	SA0651 ABA4005
BOGE	27-D54-F ABA4032	BOGE	32L41A ABA4049	BREMSI	SA0041 ABA4050	BREMSI	SA0682 ABA4019
BOGE	27D84A ABA4035	BOGE	32M74A ABA4000	BREMSI	SA0042 ABA4051	BREMSI	SA0683 ABA4053
BOGE	27E05A ABA4054	BOGE	32-N53-A ABA4075	BREMSI	SA0087 ABA4012	BREMSI	SA0685 ABA4055
BOGE	27F63A ABA4054	BOGE	32-P48-A ABA4076	BREMSI	SA0088 ABA4013	BREMSI	SA0686 ABA4056
BOGE	27-G15-A ABA4071	BOGE	32Q90A ABA4018	BREMSI	SA0089 ABA4014	BREMSI	SA0687 ABA4057
BOGE	27K26A ABA4004	BOGE	32-Q90-A ABA4053	BREMSI	SA0108 ABA4068	BREMSI	SA0688 ABA4025
BOGE	27L98A ABA4014	BOGE	32Q91A ABA4052	BREMSI	SA0109 ABA4067	BREMSI	SA0689 ABA4026
BOGE	27-M09-A ABA4071	BOGE	32-R18-A ABA4078	BREMSI	SA0121 ABA4015	BREMSI	SA0744 ABA4074
BOGE	27M33A ABA4048	BOGE	32-R19-A ABA4077	BREMSI	SA0122 ABA4016	BREMSI	SA0752 ABA4070
BOGE	27P04A ABA4046	BOGE	32-R20-A ABA4078	BREMSI	SA0123 ABA4017	BREMSI	SA0754 ABA4021
BOGE	30A570 ABA4036	BOGE	32-R21-A ABA4077	BREMSI	SA0124 ABA4070	BREMSI	SA0755 ABA4020
BOGE	30-A57-F ABA4036	BOGE	32R22A ABA4024	BREMSI	SA0126 ABA4036	BREMSI	SA0756 ABA4034
BOGE	30A75A ABA4034	BOGE	32-R71-A ABA4070	BREMSI	SA0128 ABA4032	BREMSI	SA0777 ABA4076
BOGE	30-A75-F ABA4034	BOGE	32-R72-A ABA4071	BREMSI	SA0129 ABA4032	BREMSI	SA0797 ABA4027
BOGE	30-C98-0 ABA4036	BOGE	32-R75-A ABA4040	BREMSI	SA0134 ABA4018	BREMSI	SA0798 ABA4028
BOGE	30D52A ABA4001	BOGE	32-R76-A ABA4041	BREMSI	SA0135 ABA4052	BREMSI	SA0799 ABA4029
BOGE	30D52S ABA4001	BOGE	32S01A ABA4021	BREMSI	SA0141 ABA4033	BREMSI	SA0800 ABA4030
BOGE	30D70A ABA4001	BOGE	32S02A ABA4020	BREMSI	SA0142 ABA4020	BREMSI	SA0808 ABA4074
BOGE	30D71A ABA4001	BOGE	32-S89-A ABA4070	BREMSI	SA0143 ABA4021	BREMSI	SA0838 ABA4039
BOGE	30D73A ABA4001	BOGE	32-S93-A ABA4070	BREMSI	SA0144 ABA4008	BREMSI	SA0839 ABA4075
BOGE	30D84A ABA4001	BOGE	32-T02-A ABA4074	BREMSI	SA0147 ABA4034	BREMSI	SA0840 ABA4054
BOGE	30D93A ABA4008	BOGE	32-T07-A ABA4065	BREMSI	SA0149 ABA4035	BREMSI	SA0871 ABA4006
BOGE	30-F73-F ABA4020	BOGE	32T29B ABA4056	BREMSI	SA0150 ABA4036	BREMSI	SA0872 ABA4007
BOGE	30H83A ABA4001	BOGE	32T30B ABA4057	BREMSI	SA0154 ABA4071	BREMSI	SA1187 ABA4044
BOGE	30J04A ABA4052	BOGE	32T31B ABA4055	BREMSI	SA0232 ABA4037	BREMSI	SA1188 ABA4045
BOGE	30K58A ABA4012	BOGE	32-T59-A ABA4068	BREMSI	SA0302 ABA4078	BREMSI	SA1189 ABA4046
BOGE	30K59A ABA4013	BOGE	32-T60-A ABA4067	BREMSI	SA0303 ABA4077	BREMSI	SA1473 ABA4003
BOGE	30K91A ABA4038	BOGE	32-T61-A ABA4068	BREMSI	SA0322 ABA4038	BREMSI	SA1474 ABA4077
BOGE	30L09A ABA4016	BOGE	32-T62-A ABA4067	BREMSI	SA0412 ABA4000	BREMSI	SA1475 ABA4052
BOGE	30L10A ABA4017	BOGE	32-U04-A ABA4076	BREMSI	SA0418 ABA4001	BREMSI	SA1476 ABA4053
BOGE	30L13A ABA4015	BOGE	32-U27-A ABA4059	BREMSI	SA0439 ABA4039	BREMSI	SA1870 ABA4047
BOGE	30-L92-A ABA4060	BOGE	32-U28-A ABA4058	BREMSI	SA0482 ABA4022	BREMSI	SA1878 ABA4004
BOGE	30-L95-A ABA4069	BOGE	32U42A ABA4024	BREMSI	SA0509 ABA4040	BREMSI	SA2159 ABA4048
BOGE	30M08A ABA4042	BOGE	32U98A ABA4019	BREMSI	SA0511 ABA4040	BREMSI	SA2233 ABA4063
BOGE	30M27A ABA4026	BOGE	32-U98-A ABA4052	BREMSI	SA0512 ABA4041	CHEVROLET	95077490 ABA4004
BOGE	30M28A ABA4025	BOGE	32X17A ABA4051	BREMSI	SA0514 ABA4023	DACIA	8200382033 ABA4042
BOGE	30M63A ABA4033	BOGE	32X18A ABA4050	BREMSI	SA0531 ABA4042	DACIA	8200452695 ABA4038
BOGE	30-M71-A ABA4078	BOGE	32-X46-A ABA4075	BREMSI	SA0535 ABA4024	DACIA	8200452699 ABA4042
BOGE	30-M72-A ABA4077	BOGE	36D94A ABA4011	BREMSI	SA0539 ABA4069	DACIA	8200676024 ABA4038
BOGE	30-M73-A ABA4073	BOGE	36E91A ABA4011	BREMSI	SA0557 ABA4060	DACIA	8200676026 ABA4038
BOGE	30-M77-A ABA4060	BOGE	36F22A ABA4000	BREMSI	SA0558 ABA4059	DACIA	8200702469 ABA4042
BOGE	30N33A ABA4007	BOGE	36F42A ABA4011	BREMSI	SA0559 ABA4058	DACIA	8200814535 ABA4038
BOGE	30N34A ABA4006	BOGE	36F47A ABA4011	BREMSI	SA0563 ABA4038	DACIA	543022134R ABA4038
BOGE	30N35A ABA4030	BOGE	36-G25-A ABA4073	BREMSI	SA0574 ABA4022	DACIA	562108573R ABA4042
BOGE	30N36A ABA4029	BOGE	36-G26-A ABA4072	BREMSI	SA0575 ABA4023	DAEWOO	95077490 ABA4004
BOGE	30N37A ABA4028	BOGE	36G350 ABA4047	BREMSI	SA0576 ABA4064	DAMPO	20139 ABA4022
BOGE	30N38A ABA4027	BOGE	36-G70-A ABA4063	BREMSI	SA0577 ABA4066	DAMPO	21.316 ABA4036
BOGE	30P07A ABA4045	BOGE	36-G81-A ABA4064	BREMSI	SA0578 ABA4060	DAMPO	21713 ABA4075
BOGE	30Q180 ABA4054	BOGE	36J820 ABA4037	BREMSI	SA0595 ABA4077	DAMPO	25139 ABA4022
BOGE	30Q41A ABA4003	BOGE	36K78A ABA4011	BREMSI	SA0598 ABA4072	DAMPO	26316 ABA4036
BOGE	30Q42A ABA4002	BOGE	36K80A ABA4011	BREMSI	SA0614 ABA4002	DAMPO	26321 ABA4034
BOGE	30R20A ABA4015	BOGE	36K81A ABA4011	BREMSI	SA0617 ABA4065	DAMPO	26434 ABA4075
BOGE	32-B26-0 ABA4036	BOGE	36K84A ABA4011	BREMSI	SA0636 ABA4078	DAMPO	26619 ABA4075

DAMPO	26713	ABA4075	DAMPO	27755	ABA4028	EUROREPAR	1623310380	ABA4037	EUROREPAR	1638384280	ABA4075
DAMPO	26757	ABA4075	DAMPO	27.784	ABA4002	EUROREPAR	1623310880	ABA4004	EUROREPAR	1638385180	ABA4075
DAMPO	26796	ABA4011	DAMPO	27.784	ABA4003	EUROREPAR	1623316180	ABA4024	EUROREPAR	1638389080	ABA4070
DAMPO	26800	ABA4000	DAMPO	30039	ABA4023	EUROREPAR	1623318680	ABA4042	EUROREPAR	1671541580	ABA4075
DAMPO	26.805	ABA4020	DAMPO	30134	ABA4032	EUROREPAR	1623319080	ABA4049	EUROREPAR	1671541880	ABA4075
DAMPO	26.806	ABA4021	DAMPO	35039	ABA4023	EUROREPAR	1623331280	ABA4075	EUROREPAR	1674697580	ABA4038
DAMPO	26.807	ABA4041	DAMPO	36116	ABA4032	EUROREPAR	1623332380	ABA4075	EUROREPAR	1674697680	ABA4064
DAMPO	26808	ABA4040	DAMPO	36322	ABA4035	EUROREPAR	1623332480	ABA4075	EUROREPAR	1674698580	ABA4078
DAMPO	26.823	ABA4050	DAMPO	36435	ABA4054	EUROREPAR	1623333280	ABA4070	EUROREPAR	1674698680	ABA4077
DAMPO	26.824	ABA4051	DAMPO	36457	ABA4071	EUROREPAR	1623333480	ABA4038	EUROREPAR	1674699380	ABA4012
DAMPO	26911	ABA4011	DAMPO	36620	ABA4054	EUROREPAR	1623334380	ABA4063	EUROREPAR	1674699480	ABA4013
DAMPO	26.917	ABA4018	DAMPO	36714	ABA4054	EUROREPAR	1623335480	ABA4065	EUROREPAR	1674700580	ABA4078
DAMPO	26.918	ABA4019	DAMPO	36715	ABA4054	EUROREPAR	1623335580	ABA4065	EUROREPAR	1674700880	ABA4063
DAMPO	26.960	ABA4013	DAMPO	36797	ABA4001	EUROREPAR	1623338980	ABA4077	EUROREPAR	1675666580	ABA4074
DAMPO	26.961	ABA4012	DAMPO	36804	ABA4008	EUROREPAR	1623339080	ABA4077	EUROREPAR	1675668080	ABA4065
DAMPO	26963	ABA4077	DAMPO	36809	ABA4033	EUROREPAR	1623340380	ABA4012	EUROREPAR	1675668480	ABA4055
DAMPO	26964	ABA4077	DAMPO	36825	ABA4049	EUROREPAR	1623341780	ABA4077	EUROREPAR	1675670380	ABA4060
DAMPO	26969	ABA4038	DAMPO	36912	ABA4001	EUROREPAR	1623341880	ABA4077	EUROREPAR	1675671080	ABA4046
DAMPO	26971	ABA4038	DAMPO	36919	ABA4004	EUROREPAR	1635531080	ABA4029	EUROREPAR	1675671280	ABA4024
DAMPO	26974	ABA4064	DAMPO	36962	ABA4014	EUROREPAR	1635531380	ABA4027	EUROREPAR	1675674080	ABA4005
DAMPO	27.048	ABA4002	DAMPO	36965	ABA4024	EUROREPAR	1635531680	ABA4073	EUROREPAR	1675676480	ABA4001
DAMPO	27.049	ABA4052	DAMPO	36970	ABA4042	EUROREPAR	1635531880	ABA4030	EUROREPAR	1675679480	ABA4072
DAMPO	27.049	ABA4053	DAMPO	36985	ABA4049	EUROREPAR	1635532180	ABA4028	FCA	4434805	ABA4022
DAMPO	27052	ABA4070	DAMPO	36988	ABA4049	EUROREPAR	1635532580	ABA4051	FCA	5951672	ABA4022
DAMPO	27115	ABA4043	DAMPO	37050	ABA4004	EUROREPAR	1635532980	ABA4058	FCA	5957955	ABA4022
DAMPO	27115	ABA4076	DAMPO	37053	ABA4071	EUROREPAR	1635533880	ABA4025	FCA	5967923	ABA4023
DAMPO	27353	ABA4073	DAMPO	37116	ABA4037	EUROREPAR	1635535480	ABA4059	FCA	7600789	ABA4023
DAMPO	27354	ABA4073	DAMPO	37270	ABA4033	EUROREPAR	1635536180	ABA4026	FCA	7612327	ABA4023
DAMPO	27404	ABA4063	DAMPO	37343	ABA4046	EUROREPAR	1635538280	ABA4039	FCA	7642004	ABA4023
DAMPO	27.413	ABA4016	DAMPO	37415	ABA4015	EUROREPAR	1635538680	ABA4050	FCA	7672327	ABA4023
DAMPO	27.413	ABA4017	DAMPO	37418	ABA4074	EUROREPAR	1635540080	ABA4003	FCA	7674873	ABA4023
DAMPO	27414	ABA4017	DAMPO	37421	ABA4074	EUROREPAR	1635540080	ABA4018	FCA	7705508	ABA4032
DAMPO	27416	ABA4072	DAMPO	37449	ABA4071	EUROREPAR	1635540080	ABA4052	FCA	7720251	ABA4022
DAMPO	27417	ABA4072	DAMPO	37454	ABA4005	EUROREPAR	1635540080	ABA4053	FCA	7720252	ABA4023
DAMPO	27419	ABA4072	DAMPO	37478	ABA4060	EUROREPAR	1635540080	ABA4068	FCA	46412035	ABA4032
DAMPO	27420	ABA4072	DAMPO	37481	ABA4004	EUROREPAR	1635540180	ABA4002	FCA	46420463	ABA4032
DAMPO	27445	ABA4067	DAMPO	37521	ABA4054	EUROREPAR	1635540180	ABA4019	FCA	46437781	ABA4032
DAMPO	27446	ABA4068	DAMPO	37523	ABA4047	EUROREPAR	1635540180	ABA4052	FCA	46517320	ABA4032
DAMPO	27.452	ABA4025	DAMPO	37653	ABA4055	EUROREPAR	1635540180	ABA4067	FCA	46528598	ABA4036
DAMPO	27.452	ABA4026	DAMPO	37746	ABA4060	EUROREPAR	1635542380	ABA4054	FCA	46536771	ABA4036
DAMPO	27.453	ABA4025	DAMPO	37756	ABA4024	EUROREPAR	1635542380	ABA4075	FCA	46545255	ABA4035
DAMPO	27.453	ABA4026	DAMPO	37767	ABA4033	EUROREPAR	1635542580	ABA4000	FCA	46545256	ABA4035
DAMPO	27476	ABA4058	DAMPO	37863	ABA4037	EUROREPAR	1635542780	ABA4020	FCA	46738204	ABA4035
DAMPO	27477	ABA4059	DAMPO	46975	ABA4065	EUROREPAR	1635542880	ABA4020	FCA	46739025	ABA4035
DAMPO	27.520	ABA4039	DAMPO	47406	ABA4066	EUROREPAR	1635542880	ABA4021	FCA	46749444	ABA4034
DAMPO	27.598	ABA4020	DAMPO	47447	ABA4069	EUROREPAR	1635542880	ABA4040	FCA	46749450	ABA4034
DAMPO	27.598	ABA4021	DAMPO	47725	ABA4069	EUROREPAR	1635543780	ABA4016	FCA	46754255	ABA4035
DAMPO	27.599	ABA4020	EUROREPAR	1623302980	ABA4023	EUROREPAR	1635543880	ABA4017	FCA	46755676	ABA4034
DAMPO	27.599	ABA4021	EUROREPAR	1623303280	ABA4032	EUROREPAR	1635543980	ABA4011	FCA	46770000	ABA4035
DAMPO	27.651	ABA4056	EUROREPAR	1623304180	ABA4035	EUROREPAR	1635544180	ABA4034	FCA	46770001	ABA4035
DAMPO	27.651	ABA4057	EUROREPAR	1623305580	ABA4008	EUROREPAR	1635547280	ABA4075	FCA	46786487	ABA4036
DAMPO	27.652	ABA4056	EUROREPAR	1623305680	ABA4015	EUROREPAR	1635547580	ABA4070	FCA	46786488	ABA4032
DAMPO	27.652	ABA4057	EUROREPAR	1623305780	ABA4069	EUROREPAR	1635549180	ABA4022	FCA	46809325	ABA4035
DAMPO	27708	ABA4064	EUROREPAR	1623308280	ABA4054	EUROREPAR	1635550080	ABA4075	FCA	46809326	ABA4035
DAMPO	27709	ABA4063	EUROREPAR	1623308880	ABA4054	EUROREPAR	1635551880	ABA4036	FCA	46819367	ABA4032
DAMPO	27.743	ABA4018	EUROREPAR	1623309080	ABA4004	EUROREPAR	1638380680	ABA4077	FCA	46819368	ABA4032
DAMPO	27.744	ABA4019	EUROREPAR	1623309280	ABA4071	EUROREPAR	1638382780	ABA4072	FCA	50520186	ABA4057
DAMPO	27754	ABA4027	EUROREPAR	1623309980	ABA4014	EUROREPAR	1638382880	ABA4072	FCA	50521023	ABA4004

FCA	50523950	ABA4057	FCA	50707774	ABA4033	FCA	51827234	ABA4019	FCA	51860012	ABA4016
FCA	50523952	ABA4057	FCA	50707831	ABA4041	FCA	51833503	ABA4018	FCA	51860148	ABA4016
FCA	50523954	ABA4056	FCA	50707832	ABA4040	FCA	51833504	ABA4019	FCA	51860149	ABA4016
FCA	50523954	ABA4057	FCA	50708253	ABA4040	FCA	51833511	ABA4004	FCA	51860150	ABA4015
FCA	50523956	ABA4056	FCA	50708254	ABA4041	FCA	51839569	ABA4018	FCA	51861115	ABA4019
FCA	50523980	ABA4055	FCA	50708255	ABA4040	FCA	51841916	ABA4019	FCA	51861116	ABA4018
FCA	50551339	ABA4057	FCA	50708256	ABA4041	FCA	51841917	ABA4004	FCA	51864833	ABA4015
FCA	50701477	ABA4034	FCA	50708297	ABA4041	FCA	51846884	ABA4035	FCA	51865487	ABA4019
FCA	50701483	ABA4035	FCA	50708298	ABA4040	FCA	51846885	ABA4035	FCA	51865488	ABA4019
FCA	50701484	ABA4035	FCA	50708669	ABA4017	FCA	51851835	ABA4016	FCA	51865489	ABA4019
FCA	50701550	ABA4034	FCA	50708670	ABA4016	FCA	51856392	ABA4009	FCA	51865490	ABA4019
FCA	50701556	ABA4034	FCA	50708671	ABA4017	FCA	51856392	ABA4021	FCA	51865491	ABA4019
FCA	50701916	ABA4035	FCA	50708672	ABA4016	FCA	51856393	ABA4010	FCA	51866699	ABA4019
FCA	50701917	ABA4035	FCA	50708673	ABA4017	FCA	51856393	ABA4020	FCA	51870990	ABA4008
FCA	50701922	ABA4035	FCA	50708674	ABA4016	FCA	51856394	ABA4033	FCA	51873204	ABA4009
FCA	50701923	ABA4035	FCA	50708786	ABA4015	FCA	51857278	ABA4008	FCA	51873204	ABA4021
FCA	50703297	ABA4010	FCA	50708787	ABA4015	FCA	51857279	ABA4008	FCA	51873205	ABA4010
FCA	50703297	ABA4020	FCA	50709077	ABA4016	FCA	51857282	ABA4033	FCA	51873205	ABA4020
FCA	50703298	ABA4009	FCA	50709078	ABA4017	FCA	51857283	ABA4033	FCA	51880026	ABA4017
FCA	50703298	ABA4021	FCA	50709079	ABA4017	FCA	51857284	ABA4033	FCA	51943197	ABA4004
FCA	50703308	ABA4010	FCA	50709080	ABA4016	FCA	51857285	ABA4033	FCA	51943198	ABA4004
FCA	50703308	ABA4020	FCA	50709081	ABA4015	FCA	51857300	ABA4010	FCA	51943199	ABA4004
FCA	50703309	ABA4009	FCA	50709082	ABA4015	FCA	51857300	ABA4020	FCA	51957098	ABA4015
FCA	50703309	ABA4021	FCA	50709730	ABA4015	FCA	51857301	ABA4009	FCA	51964352	ABA4017
FCA	50703574	ABA4035	FCA	50709731	ABA4015	FCA	51857304	ABA4041	FCA	51964354	ABA4016
FCA	50703744	ABA4009	FCA	50709732	ABA4015	FCA	51857305	ABA4041	FCA	51968044	ABA4004
FCA	50703744	ABA4021	FCA	50709891	ABA4033	FCA	51857306	ABA4041	FCA	51984162	ABA4015
FCA	50703745	ABA4010	FCA	50709892	ABA4033	FCA	51857307	ABA4009	FCA	52070349	ABA4015
FCA	50703745	ABA4020	FCA	50710823	ABA4033	FCA	51857307	ABA4021	FCA	52071310	ABA4015
FCA	50703768	ABA4033	FCA	50710824	ABA4033	FCA	51857325	ABA4010	FCA	55700452	ABA4004
FCA	50703824	ABA4035	FCA	50710827	ABA4040	FCA	51857328	ABA4040	FCA	55700608	ABA4004
FCA	50703825	ABA4035	FCA	50710828	ABA4041	FCA	51857329	ABA4040	FCA	55700783	ABA4018
FCA	50703826	ABA4035	FCA	50710829	ABA4040	FCA	51857330	ABA4040	FCA	55702651	ABA4019
FCA	50703827	ABA4035	FCA	50710830	ABA4041	FCA	51857331	ABA4010	FCA	55703656	ABA4019
FCA	50703893	ABA4009	FCA	50710833	ABA4040	FCA	51857331	ABA4020	FCA	55703657	ABA4019
FCA	50703893	ABA4021	FCA	50710834	ABA4041	FCA	51857832	ABA4017	FCA	55703658	ABA4019
FCA	50703894	ABA4010	FCA	50711043	ABA4009	FCA	51857833	ABA4016	FCA	55703660	ABA4018
FCA	50703894	ABA4020	FCA	50711043	ABA4021	FCA	51857834	ABA4016	FCA	55703661	ABA4018
FCA	50703895	ABA4008	FCA	50711044	ABA4010	FCA	51857834	ABA4017	FCA	55703662	ABA4018
FCA	50703987	ABA4035	FCA	50711044	ABA4020	FCA	51857835	ABA4016	FCA	71712473	ABA4023
FCA	50703988	ABA4035	FCA	50711334	ABA4034	FCA	51857835	ABA4017	FCA	71712477	ABA4023
FCA	50704226	ABA4009	FCA	51700257	ABA4036	FCA	51857840	ABA4015	FCA	71712479	ABA4023
FCA	50704226	ABA4021	FCA	51778802	ABA4035	FCA	51857841	ABA4015	FCA	71718283	ABA4023
FCA	50704227	ABA4010	FCA	51778803	ABA4035	FCA	51857842	ABA4015	FCA	71736464	ABA4023
FCA	50704227	ABA4020	FCA	51783653	ABA4019	FCA	51857947	ABA4033	FCA	71736466	ABA4023
FCA	50704323	ABA4040	FCA	51783654	ABA4018	FCA	51857948	ABA4010	FCA	71736467	ABA4022
FCA	50704713	ABA4041	FCA	51796541	ABA4018	FCA	51857948	ABA4020	FCA	71736469	ABA4022
FCA	50705254	ABA4035	FCA	51796542	ABA4018	FCA	51857949	ABA4009	FISPA	F210G0362	ABA4050
FCA	50705255	ABA4035	FCA	51796543	ABA4018	FCA	51857949	ABA4021	FISPA	F210G0363	ABA4051
FCA	50705256	ABA4035	FCA	51796544	ABA4018	FCA	51857950	ABA4009	FISPA	F210G0364	ABA4020
FCA	50705257	ABA4035	FCA	51796545	ABA4019	FCA	51857950	ABA4010	FISPA	F210G0365	ABA4021
FCA	50705347	ABA4041	FCA	51796546	ABA4019	FCA	51857950	ABA4020	FISPA	F210G0376	ABA4019
FCA	50705348	ABA4040	FCA	51796547	ABA4019	FCA	51857950	ABA4021	FISPA	F210G0376	ABA4052
FCA	50705349	ABA4033	FCA	51796548	ABA4019	FCA	51857951	ABA4009	FISPA	F210G0377	ABA4018
FCA	50705455	ABA4041	FCA	51805996	ABA4035	FCA	51857951	ABA4010	FISPA	F210G0377	ABA4053
FCA	50705456	ABA4040	FCA	51812082	ABA4035	FCA	51857951	ABA4020	FISPA	F210G0606	ABA4038
FCA	50705457	ABA4033	FCA	51826536	ABA4004	FCA	51857951	ABA4021	FISPA	F210G1099	ABA4013
FCA	50706065	ABA4008	FCA	51827233	ABA4018	FCA	51860011	ABA4017	FISPA	F210G1100	ABA4012

FISPA	F210G1121	ABA4044	FORD	1555037	ABA4025	FORD	1853310	ABA4005	GOLD	9130672	ABA4032
FISPA	F210G1122	ABA4045	FORD	1555038	ABA4025	FORD	1853311	ABA4005	GOLD	9130740	ABA4015
FISPA	F210G1417	ABA4036	FORD	1555039	ABA4005	FORD	1874054	ABA4006	GOLD	9130744	ABA4054
FISPA	F210G1418	ABA4036	FORD	1561832	ABA4026	FORD	1874055	ABA4007	GOLD	9130745	ABA4054
FISPA	F210G1420	ABA4022	FORD	1561833	ABA4026	FORD	1896679	ABA4007	GOLD	9130981	ABA4071
FISPA	F210G1423	ABA4034	FORD	1561840	ABA4025	FORD	1896681	ABA4007	GOLD	9131100	ABA4005
FISPA	F210G1427	ABA4025	FORD	1576246	ABA4005	FORD	1896682	ABA4006	GOLD	9131149	ABA4047
FISPA	F210G1428	ABA4026	FORD	1682492	ABA4005	FORD	1896683	ABA4006	GOLD	9131414	ABA4046
FISPA	F210G1433	ABA4038	FORD	1713956	ABA4026	FORD	1899012	ABA4005	GOLD	9131725	ABA4037
FISPA	F210G1445	ABA4000	FORD	1713958	ABA4026	FORD	1899013	ABA4005	GOLD	9150221	ABA4049
FISPA	F210G1451	ABA4039	FORD	1713959	ABA4026	FORD	1899988	ABA4007	GOLD	9150529	ABA4071
FISPA	F210G1452	ABA4017	FORD	1713961	ABA4026	FORD	1904582	ABA4006	GOLD	9150536	ABA4001
FISPA	F210G1453	ABA4016	FORD	1713973	ABA4025	FORD	1904584	ABA4006	GOLD	9150616	ABA4069
FISPA	F210G1454	ABA4011	FORD	1713974	ABA4025	FORD	1904589	ABA4006	GOLD	9150617	ABA4042
FISPA	F210G1455	ABA4043	FORD	1713975	ABA4025	FORD	1904590	ABA4006	GOLD	9150635	ABA4024
FISPA	F210G1456	ABA4040	FORD	1713976	ABA4025	FORD	1904601	ABA4007	GOLD	9150717	ABA4060
FISPA	F210G1457	ABA4041	FORD	1721234	ABA4005	FORD	1904608	ABA4007	GOLD	9150811	ABA4074
FISPA	F210G1485	ABA4052	FORD	1721236	ABA4005	FORD	1904611	ABA4007	GOLD	9150846	ABA4060
FISPA	F210G1486	ABA4053	FORD	1721237	ABA4005	FORD	1933670	ABA4005	GOLD	9151070	ABA4074
FISPA	F210G1557	ABA4029	FORD	1730506	ABA4025	FORD	1940673	ABA4005	GOLD	9151100	ABA4074
FISPA	F210G1558	ABA4030	FORD	1737252	ABA4025	FORD	1940674	ABA4005	GOLD	9160285	ABA4066
FISPA	F210G1586	ABA4027	FORD	1737264	ABA4026	FORD	1940675	ABA4005	GOLD	9160473	ABA4065
FISPA	F210G1587	ABA4028	FORD	1737265	ABA4026	FORD	2025091	ABA4007	GOLD	9230001	ABA4036
FISPA	F210G1593	ABA4057	FORD	1737267	ABA4005	FORD	2025092	ABA4006	GOLD	9230007	ABA4048
FISPA	F210G1594	ABA4056	FORD	1737275	ABA4005	FORD	2025093	ABA4006	GOLD	9250373	ABA4021
FISPA	F220G0361	ABA4049	FORD	1737276	ABA4005	FORD	2025094	ABA4006	GOLD	9250374	ABA4020
FISPA	F220G0366	ABA4008	FORD	1740294	ABA4025	FORD	2025100	ABA4007	GOLD	9250487	ABA4021
FISPA	F220G0375	ABA4004	FORD	1740297	ABA4005	FORD	2025102	ABA4006	GOLD	9250488	ABA4020
FISPA	F220G1039	ABA4014	FORD	1740298	ABA4025	FORD	2025112	ABA4007	GOLD	9250591	ABA4067
FISPA	F220G1240	ABA4032	FORD	1740301	ABA4026	FORD	2037774	ABA4007	GOLD	9250592	ABA4068
FISPA	F220G1256	ABA4015	FORD	1740303	ABA4026	FORD	2037779	ABA4006	GOLD	9250713	ABA4034
FISPA	F220G1260	ABA4023	FORD	1740731	ABA4005	FORD	2037788	ABA4006	GOLD	9250853	ABA4013
FISPA	F220G1265	ABA4033	FORD	1754841	ABA4005	FORD	2037959	ABA4006	GOLD	9250854	ABA4012
FISPA	F220G1277	ABA4032	FORD	1754843	ABA4005	FORD	2037968	ABA4006	GOLD	9250863	ABA4022
FISPA	F220G1285	ABA4024	FORD	1783630	ABA4007	FORD	2037969	ABA4006	GOLD	9250993	ABA4038
FISPA	F220G1323	ABA4035	FORD	1783640	ABA4006	FORD	2037970	ABA4007	GOLD	9251035	ABA4017
FISPA	F220G1343	ABA4054	FORD	1789511	ABA4006	FORD	2037974	ABA4007	GOLD	9251036	ABA4016
FISPA	F220G1360	ABA4005	FORD	1789514	ABA4007	FORD	2037975	ABA4007	GOLD	9251326	ABA4026
FISPA	F220G1364	ABA4037	FORD	1795371	ABA4006	FORD	2037978	ABA4006	GOLD	9251437	ABA4077
FISPA	F220G1378	ABA4001	FORD	1795662	ABA4007	FORD	2037979	ABA4007	GOLD	9251438	ABA4078
FISPA	F220G1389	ABA4047	FORD	1804018	ABA4005	FORD	2101620	ABA4005	GOLD	9260223	ABA4075
FISPA	F220G1391	ABA4042	FORD	1807255	ABA4005	FORD	2101627	ABA4005	GOLD	9260593	ABA4070
FISPA	F220G1394	ABA4055	FORD	1809589	ABA4007	FORD	2110021	ABA4005	GOLD	9260743	ABA4072
FORD	1514407	ABA4005	FORD	1809601	ABA4006	GOLD	7170171	ABA4054	GOLD	9260744	ABA4073
FORD	1535227	ABA4026	FORD	1829035	ABA4006	GOLD	8130653	ABA4023	GOLD	9260845	ABA4051
FORD	1535228	ABA4025	FORD	1829037	ABA4006	GOLD	8130672	ABA4032	GOLD	9260846	ABA4050
FORD	1535747	ABA4026	FORD	1829038	ABA4006	GOLD	8230003	ABA4036	GOLD	9260941	ABA4000
FORD	1535749	ABA4025	FORD	1829039	ABA4006	GOLD	8250863	ABA4022	GOLD	9260959	ABA4039
FORD	1547172	ABA4026	FORD	1829043	ABA4007	GOLD	8250993	ABA4038	GOLD	9261065	ABA4057
FORD	1547173	ABA4026	FORD	1829046	ABA4007	GOLD	8260080	ABA4075	GOLD	9261066	ABA4056
FORD	1547174	ABA4025	FORD	1829047	ABA4007	GOLD	9130017	ABA4035	GOLD	9261103	ABA4040
FORD	1547175	ABA4025	FORD	1829048	ABA4007	GOLD	9130174	ABA4054	GOLD	9261104	ABA4041
FORD	1547176	ABA4005	FORD	1848804	ABA4005	GOLD	9130328	ABA4071	GOLD	9261317	ABA4043
FORD	1547216	ABA4026	FORD	1848805	ABA4005	GOLD	9130341	ABA4008	GOLD	9261331	ABA4075
FORD	1547219	ABA4025	FORD	1848806	ABA4005	GOLD	9130624	ABA4004	GOLD	9261379	ABA4076
FORD	1547220	ABA4025	FORD	1849456	ABA4005	GOLD	9130647	ABA4014	GOLD	9261549	ABA4077
FORD	1547221	ABA4005	FORD	1849457	ABA4005	GOLD	9130652	ABA4033	GOLD	9261550	ABA4078
FORD	1555036	ABA4026	FORD	1853309	ABA4005	GOLD	9130653	ABA4023	GOLD	9261739	ABA4058

GOLD	9261740	ABA4059	GOOM	F210G1586	ABA4027	HERTH + BUSS	J4310870	ABA4051	JAPANPARTS	MM-00499	ABA4054
GOLD	9262195	ABA4002	GOOM	F210G1587	ABA4028	HERTH + BUSS	J4310877	ABA4027	JAPANPARTS	MM-00525	ABA4039
GOLD	9262196	ABA4003	GOOM	F210G1593	ABA4057	HERTH + BUSS	J4310878	ABA4029	JAPANPARTS	MM-00552	ABA4063
GOLD	9262201	ABA4077	GOOM	F210G1594	ABA4056	HERTH + BUSS	J4310895	ABA4006	JAPANPARTS	MM-00577	ABA4022
GOLD	9262202	ABA4078	GOOM	F220G0361	ABA4049	HERTH + BUSS	J4310897	ABA4058	JAPANPARTS	MM-00606	ABA4040
GOLD	9262205	ABA4052	GOOM	F220G0366	ABA4008	HERTH + BUSS	J4312001	ABA4013	JAPANPARTS	MM-00608	ABA4040
GOLD	9262206	ABA4052	GOOM	F220G0375	ABA4004	HERTH + BUSS	J4312011	ABA4044	JAPANPARTS	MM-00609	ABA4041
GOLD	9262747	ABA4019	GOOM	F220G1039	ABA4014	HERTH + BUSS	J4320807	ABA4001	JAPANPARTS	MM-00612	ABA4023
GOLD	9262747	ABA4052	GOOM	F220G1240	ABA4032	HERTH + BUSS	J4320809	ABA4054	JAPANPARTS	MM-00629	ABA4042
GOLD	9262748	ABA4018	GOOM	F220G1256	ABA4015	HERTH + BUSS	J4320810	ABA4049	JAPANPARTS	MM-00633	ABA4024
GOLD	9262748	ABA4053	GOOM	F220G1260	ABA4023	HERTH + BUSS	J43208108	ABA4071	JAPANPARTS	MM-00637	ABA4069
GOLD	9263105	ABA4044	GOOM	F220G1265	ABA4033	HERTH + BUSS	J4320813	ABA4042	JAPANPARTS	MM-00661	ABA4060
GOLD	9263106	ABA4045	GOOM	F220G1277	ABA4032	HERTH + BUSS	J4320814	ABA4037	JAPANPARTS	MM-00664	ABA4059
GOLD	9263113	ABA4070	GOOM	F220G1285	ABA4024	HERTH + BUSS	J4320815	ABA4015	JAPANPARTS	MM-00665	ABA4058
GOLD	9263187	ABA4027	GOOM	F220G1323	ABA4035	HERTH + BUSS	J4320817	ABA4032	JAPANPARTS	MM-00672	ABA4038
GOLD	9263188	ABA4028	GOOM	F220G1343	ABA4054	HERTH + BUSS	J4320823	ABA4023	JAPANPARTS	MM-00688	ABA4022
GOLD	9263237	ABA4039	GOOM	F220G1360	ABA4005	HERTH + BUSS	J4320824	ABA4023	JAPANPARTS	MM-00689	ABA4023
GOLD	9263747	ABA4029	GOOM	F220G1364	ABA4037	HERTH + BUSS	J4320825	ABA4033	JAPANPARTS	MM-00691	ABA4064
GOLD	9263748	ABA4030	GOOM	F220G1378	ABA4001	HERTH + BUSS	J4320836	ABA4005	JAPANPARTS	MM-00692	ABA4066
GOLD	9263977	ABA4040	GOOM	F220G1389	ABA4047	HERTH + BUSS	J4320853	ABA4054	JAPANPARTS	MM-00693	ABA4060
GOLD	9270023	ABA4064	GOOM	F220G1391	ABA4042	HERTH + BUSS	J4320873	ABA4066	JAPANPARTS	MM-00711	ABA4074
GOLD	9270049	ABA4011	GOOM	F220G1394	ABA4055	HERTH + BUSS	J4320875	ABA4024	JAPANPARTS	MM-00712	ABA4077
GOLD	9450445	ABA4055	HERTH + BUSS	J4310856	ABA4072	HERTH + BUSS	J4320887	ABA4069	JAPANPARTS	MM-00715	ABA4072
GOLD	G00552	ABA4063	HERTH + BUSS	J43008100	ABA4078	HERTH + BUSS	J4320902	ABA4004	JAPANPARTS	MM-00716	ABA4073
GOLD	G01082	ABA4006	HERTH + BUSS	J43008110	ABA4070	HERTH + BUSS	J4322005	ABA4014	JAPANPARTS	MM-00731	ABA4002
GOLD	G01083	ABA4007	HERTH + BUSS	J4300812	ABA4011	JAPANPARTS	MM-00029	ABA4075	JAPANPARTS	MM-00734	ABA4065
GOOM	F210G0362	ABA4050	HERTH + BUSS	J4300813	ABA4000	JAPANPARTS	MM-00030	ABA4054	JAPANPARTS	MM-00755	ABA4078
GOOM	F210G0363	ABA4051	HERTH + BUSS	J4300814	ABA4073	JAPANPARTS	MM-00031	ABA4011	JAPANPARTS	MM-00760	ABA4071
GOOM	F210G0364	ABA4020	HERTH + BUSS	J4300816	ABA4039	JAPANPARTS	MM-00057	ABA4049	JAPANPARTS	MM-00763	ABA4078
GOOM	F210G0365	ABA4021	HERTH + BUSS	J4300818	ABA4034	JAPANPARTS	MM-00058	ABA4050	JAPANPARTS	MM-00767	ABA4043
GOOM	F210G0376	ABA4019	HERTH + BUSS	J4300819	ABA4026	JAPANPARTS	MM-00059	ABA4051	JAPANPARTS	MM-00770	ABA4005
GOOM	F210G0376	ABA4052	HERTH + BUSS	J4300820	ABA4018	JAPANPARTS	MM-00119	ABA4012	JAPANPARTS	MM-00822	ABA4019
GOOM	F210G0377	ABA4018	HERTH + BUSS	J4300820	ABA4053	JAPANPARTS	MM-00120	ABA4013	JAPANPARTS	MM-00823	ABA4018
GOOM	F210G0377	ABA4053	HERTH + BUSS	J4300823	ABA4064	JAPANPARTS	MM-00121	ABA4014	JAPANPARTS	MM-00826	ABA4055
GOOM	F210G0606	ABA4038	HERTH + BUSS	J4300824	ABA4016	JAPANPARTS	MM-00142	ABA4068	JAPANPARTS	MM-00828	ABA4056
GOOM	F210G1099	ABA4013	HERTH + BUSS	J4300828	ABA4022	JAPANPARTS	MM-00143	ABA4067	JAPANPARTS	MM-00829	ABA4057
GOOM	F210G1100	ABA4012	HERTH + BUSS	J4300829	ABA4022	JAPANPARTS	MM-00160	ABA4015	JAPANPARTS	MM-00831	ABA4025
GOOM	F210G1121	ABA4044	HERTH + BUSS	J4300834	ABA4075	JAPANPARTS	MM-00161	ABA4016	JAPANPARTS	MM-00832	ABA4026
GOOM	F210G1122	ABA4045	HERTH + BUSS	J4300841	ABA4038	JAPANPARTS	MM-00162	ABA4017	JAPANPARTS	MM-00903	ABA4074
GOOM	F210G1417	ABA4036	HERTH + BUSS	J4300848	ABA4036	JAPANPARTS	MM-00163	ABA4070	JAPANPARTS	MM-00915	ABA4070
GOOM	F210G1418	ABA4036	HERTH + BUSS	J4300851	ABA4043	JAPANPARTS	MM-00165	ABA4036	JAPANPARTS	MM-00919	ABA4021
GOOM	F210G1420	ABA4022	HERTH + BUSS	J4300852	ABA4076	JAPANPARTS	MM-00167	ABA4032	JAPANPARTS	MM-00920	ABA4020
GOOM	F210G1423	ABA4034	HERTH + BUSS	J4300856	ABA4073	JAPANPARTS	MM-00168	ABA4032	JAPANPARTS	MM-00921	ABA4034
GOOM	F210G1427	ABA4025	HERTH + BUSS	J4300863	ABA4038	JAPANPARTS	MM-00180	ABA4033	JAPANPARTS	MM-00953	ABA4076
GOOM	F210G1428	ABA4026	HERTH + BUSS	J4300870	ABA4050	JAPANPARTS	MM-00181	ABA4020	JAPANPARTS	MM-00976	ABA4027
GOOM	F210G1433	ABA4038	HERTH + BUSS	J4300877	ABA4028	JAPANPARTS	MM-00182	ABA4021	JAPANPARTS	MM-00977	ABA4028
GOOM	F210G1445	ABA4000	HERTH + BUSS	J4300878	ABA4030	JAPANPARTS	MM-00183	ABA4008	JAPANPARTS	MM-00978	ABA4029
GOOM	F210G1451	ABA4039	HERTH + BUSS	J4300886	ABA4003	JAPANPARTS	MM-00186	ABA4034	JAPANPARTS	MM-00979	ABA4030
GOOM	F210G1452	ABA4017	HERTH + BUSS	J4300895	ABA4007	JAPANPARTS	MM-00188	ABA4035	JAPANPARTS	MM-00987	ABA4074
GOOM	F210G1453	ABA4016	HERTH + BUSS	J4300897	ABA4059	JAPANPARTS	MM-00189	ABA4036	JAPANPARTS	MM-01028	ABA4039
GOOM	F210G1454	ABA4011	HERTH + BUSS	J4302001	ABA4012	JAPANPARTS	MM-00190	ABA4071	JAPANPARTS	MM-01031	ABA4075
GOOM	F210G1455	ABA4043	HERTH + BUSS	J4302011	ABA4045	JAPANPARTS	MM-00193	ABA4071	JAPANPARTS	MM-01034	ABA4054
GOOM	F210G1456	ABA4040	HERTH + BUSS	J43108100	ABA4077	JAPANPARTS	MM-00289	ABA4037	JAPANPARTS	MM-01082	ABA4006
GOOM	F210G1457	ABA4041	HERTH + BUSS	J4310814	ABA4072	JAPANPARTS	MM-00371	ABA4078	JAPANPARTS	MM-01083	ABA4007
GOOM	F210G1485	ABA4052	HERTH + BUSS	J4310819	ABA4025	JAPANPARTS	MM-00372	ABA4077	JAPANPARTS	MM-22081	ABA4044
GOOM	F210G1486	ABA4053	HERTH + BUSS	J4310820	ABA4019	JAPANPARTS	MM-00393	ABA4038	JAPANPARTS	MM-22082	ABA4045
GOOM	F210G1557	ABA4029	HERTH + BUSS	J4310820	ABA4052	JAPANPARTS	MM-00492	ABA4000	JAPANPARTS	MM-22083	ABA4046
GOOM	F210G1558	ABA4030	HERTH + BUSS	J4310824	ABA4017	JAPANPARTS	MM-00498	ABA4001	JAPANPARTS	MM-50061	ABA4003

JAPANPARTS	MM-50062	ABA4077	JAPKO	MJ00692	ABA4066	KAMOKA	2000039	ABA4065	KAMOKA	2000953	ABA4060
JAPANPARTS	MM-50063	ABA4052	JAPKO	MJ00693	ABA4060	KAMOKA	2000040	ABA4037	KAMOKA	2000968	ABA4032
JAPANPARTS	MM-50064	ABA4053	JAPKO	MJ00711	ABA4074	KAMOKA	2000053	ABA4005	KAMOKA	2001043	ABA4036
JAPANPARTS	MM-SMA04	ABA4047	JAPKO	MJ00712	ABA4077	KAMOKA	2000074	ABA4069	KAMOKA	2001047	ABA4075
JAPANPARTS	MM-SMA05	ABA4048	JAPKO	MJ00715	ABA4072	KAMOKA	2000086	ABA4043	KAMOKA	2001059	ABA4038
JAPANPARTS	MM-W0004	ABA4004	JAPKO	MJ00716	ABA4073	KAMOKA	2000088	ABA4076	KAMOKA	20300035	ABA4074
JAPANPARTS	MM-W0016	ABA4075	JAPKO	MJ00731	ABA4002	KAMOKA	2000092	ABA4056	KAMOKA	20300040	ABA4065
JAPKO	MJ00029	ABA4075	JAPKO	MJ00734	ABA4065	KAMOKA	2000093	ABA4057	KAMOKA	20300041	ABA4065
JAPKO	MJ00030	ABA4054	JAPKO	MJ00755	ABA4078	KAMOKA	2000097	ABA4055	KAMOKA	20300083	ABA4069
JAPKO	MJ00031	ABA4011	JAPKO	MJ00760	ABA4071	KAMOKA	2000129	ABA4013	KAMOKA	20300101	ABA4076
JAPKO	MJ00057	ABA4049	JAPKO	MJ00763	ABA4078	KAMOKA	2000130	ABA4012	KAMOKA	20333012	ABA4077
JAPKO	MJ00058	ABA4050	JAPKO	MJ00767	ABA4043	KAMOKA	2000142	ABA4077	KAMOKA	20333013	ABA4078
JAPKO	MJ00059	ABA4051	JAPKO	MJ00770	ABA4005	KAMOKA	2000143	ABA4078	KAMOKA	20333068	ABA4075
JAPKO	MJ00119	ABA4012	JAPKO	MJ00822	ABA4019	KAMOKA	2000144	ABA4017	KAMOKA	20335003	ABA4063
JAPKO	MJ00120	ABA4013	JAPKO	MJ00822	ABA4052	KAMOKA	2000145	ABA4016	KAMOKA	20335005	ABA4064
JAPKO	MJ00121	ABA4014	JAPKO	MJ00823	ABA4018	KAMOKA	2000187	ABA4029	KAMOKA	20335041	ABA4064
JAPKO	MJ00142	ABA4068	JAPKO	MJ00823	ABA4053	KAMOKA	2000188	ABA4030	KAMOKA	20339021	ABA4072
JAPKO	MJ00143	ABA4067	JAPKO	MJ00826	ABA4055	KAMOKA	2000189	ABA4027	KAMOKA	20339022	ABA4073
JAPKO	MJ00160	ABA4015	JAPKO	MJ00828	ABA4056	KAMOKA	2000190	ABA4028	KAMOKA	20339025	ABA4058
JAPKO	MJ00161	ABA4016	JAPKO	MJ00829	ABA4057	KAMOKA	2000205	ABA4021	KAMOKA	20339026	ABA4059
JAPKO	MJ00162	ABA4017	JAPKO	MJ00831	ABA4025	KAMOKA	2000206	ABA4020	KAMOKA	20343312	ABA4071
JAPKO	MJ00163	ABA4070	JAPKO	MJ00832	ABA4026	KAMOKA	2000230	ABA4038	KAMOKA	20343391	ABA4054
JAPKO	MJ00165	ABA4036	JAPKO	MJ00903	ABA4074	KAMOKA	2000295	ABA4050	KAMOKA	20349947	ABA4060
JAPKO	MJ00167	ABA4032	JAPKO	MJ00915	ABA4070	KAMOKA	2000296	ABA4051	KAMOKA	20633068	ABA4075
JAPKO	MJ00168	ABA4032	JAPKO	MJ00919	ABA4021	KAMOKA	2000336	ABA4019	KAVO PARTS	SSA10001	ABA4017
JAPKO	MJ00180	ABA4033	JAPKO	MJ00920	ABA4020	KAMOKA	2000336	ABA4052	KAVO PARTS	SSA10002	ABA4016
JAPKO	MJ00181	ABA4020	JAPKO	MJ00921	ABA4034	KAMOKA	2000337	ABA4018	KAVO PARTS	SSA10003	ABA4019
JAPKO	MJ00182	ABA4021	JAPKO	MJ00953	ABA4076	KAMOKA	2000337	ABA4053	KAVO PARTS	SSA-10003	ABA4052
JAPKO	MJ00183	ABA4008	JAPKO	MJ00976	ABA4027	KAMOKA	2000350	ABA4006	KAVO PARTS	SSA10004	ABA4018
JAPKO	MJ00186	ABA4034	JAPKO	MJ00977	ABA4028	KAMOKA	2000351	ABA4007	KAVO PARTS	SSA-10004	ABA4053
JAPKO	MJ00188	ABA4035	JAPKO	MJ00978	ABA4029	KAMOKA	2000374	ABA4018	KAVO PARTS	SSA10005	ABA4015
JAPKO	MJ00189	ABA4036	JAPKO	MJ00979	ABA4030	KAMOKA	2000374	ABA4053	KAVO PARTS	SSA-10011	ABA4075
JAPKO	MJ00190	ABA4071	JAPKO	MJ00987	ABA4074	KAMOKA	2000377	ABA4000	KAVO PARTS	SSA10012	ABA4000
JAPKO	MJ00193	ABA4071	JAPKO	MJ01028	ABA4039	KAMOKA	2000385	ABA4034	KAVO PARTS	SSA10013	ABA4039
JAPKO	MJ00289	ABA4037	JAPKO	MJ01031	ABA4075	KAMOKA	2000467	ABA4064	KAVO PARTS	SSA10022	ABA4054
JAPKO	MJ00371	ABA4078	JAPKO	MJ01034	ABA4054	KAMOKA	2000484	ABA4011	KAVO PARTS	SSA10023	ABA4001
JAPKO	MJ00372	ABA4077	JAPKO	MJ01082	ABA4006	KAMOKA	2000487	ABA4026	KAVO PARTS	SSA10039	ABA4049
JAPKO	MJ00393	ABA4038	JAPKO	MJ01083	ABA4007	KAMOKA	2000488	ABA4025	KAVO PARTS	SSA-10058	ABA4067
JAPKO	MJ00492	ABA4000	JAPKO	MJ22081	ABA4044	KAMOKA	2000524	ABA4072	KAVO PARTS	SSA-10059	ABA4064
JAPKO	MJ00498	ABA4001	JAPKO	MJ22082	ABA4045	KAMOKA	2000525	ABA4073	KAVO PARTS	SSA1006	ABA4004
JAPKO	MJ00499	ABA4054	JAPKO	MJ22083	ABA4046	KAMOKA	2000528	ABA4058	KAVO PARTS	SSA-10071	ABA4065
JAPKO	MJ00525	ABA4039	JAPKO	MJ50061	ABA4003	KAMOKA	2000529	ABA4059	KAVO PARTS	SSA-10072	ABA4066
JAPKO	MJ00552	ABA4063	JAPKO	MJ50062	ABA4077	KAMOKA	2000572	ABA4040	KAVO PARTS	SSA10074	ABA4024
JAPKO	MJ00577	ABA4022	JAPKO	MJ50063	ABA4052	KAMOKA	2000574	ABA4040	KAVO PARTS	SSA-10075	ABA4069
JAPKO	MJ00606	ABA4040	JAPKO	MJ50064	ABA4052	KAMOKA	2000575	ABA4041	KAVO PARTS	SSA10088	ABA4021
JAPKO	MJ00608	ABA4040	JAPKO	MJ50064	ABA4053	KAMOKA	2000596	ABA4052	KAVO PARTS	SSA10089	ABA4020
JAPKO	MJ00609	ABA4041	JAPKO	MJSMA04	ABA4047	KAMOKA	2000597	ABA4053	KAVO PARTS	SSA10091	ABA4036
JAPKO	MJ00612	ABA4023	JAPKO	MJSMA05	ABA4048	KAMOKA	2000736	ABA4046	KAVO PARTS	SSA10096	ABA4034
JAPKO	MJ00629	ABA4042	JAPKO	MJW0004	ABA4004	KAMOKA	2000744	ABA4054	KAVO PARTS	SSA-10098	ABA4070
JAPKO	MJ00633	ABA4024	JAPKO	MJW0016	ABA4075	KAMOKA	2000775	ABA4071	KAVO PARTS	SSA10099	ABA4040
JAPKO	MJ00637	ABA4069	KAMOKA	2000001	ABA4024	KAMOKA	2000779	ABA4004	KAVO PARTS	SSA10100	ABA4041
JAPKO	MJ00661	ABA4060	KAMOKA	2000008	ABA4068	KAMOKA	2000783	ABA4008	KAVO PARTS	SSA-10101	ABA4058
JAPKO	MJ00664	ABA4059	KAMOKA	2000009	ABA4067	KAMOKA	2000787	ABA4014	KAVO PARTS	SSA-10102	ABA4059
JAPKO	MJ00665	ABA4058	KAMOKA	2000014	ABA4052	KAMOKA	2000800	ABA4015	KAVO PARTS	SSA10103	ABA4032
JAPKO	MJ00672	ABA4038	KAMOKA	2000014	ABA4053	KAMOKA	2000857	ABA4001	KAVO PARTS	SSA10105	ABA4035
JAPKO	MJ00688	ABA4022	KAMOKA	2000015	ABA4002	KAMOKA	2000878	ABA4042	KAVO PARTS	SSA-10106	ABA4071
JAPKO	MJ00689	ABA4023	KAMOKA	2000015	ABA4053	KAMOKA	2000901	ABA4033	KAVO PARTS	SSA10107	ABA4008
JAPKO	MJ00691	ABA4064	KAMOKA	2000021	ABA4039	KAMOKA	2000946	ABA4049	KAVO PARTS	SSA10112	ABA4033

KAVO PARTS	SSA-10115	ABA4060	KYB	335808	ABA4011	KYB	633744	ABA4038	M.MARELLI	350745080000	ABA4022
KAVO PARTS	SSA10143	ABA4005	KYB	335827	ABA4064	KYB	3338012	ABA4029	M.MARELLI	350904080000	ABA4023
KAVO PARTS	SSA10159	ABA4043	KYB	338731	ABA4025	KYB	3338013	ABA4030	M.MARELLI	351231070000	ABA4049
KAVO PARTS	SSA10168	ABA4037	KYB	338732	ABA4026	KYB	3338014	ABA4027	M.MARELLI	351432070000	ABA4075
KAVO PARTS	SSA-10173	ABA4076	KYB	339707	ABA4077	KYB	3338015	ABA4028	M.MARELLI	351732070000	ABA4032
KAVO PARTS	SSA10181	ABA4002	KYB	339708	ABA4078	KYB	3348003	ABA4019	M.MARELLI	351746070000	ABA4071
KAVO PARTS	SSA10181	ABA4052	KYB	339714	ABA4002	KYB	3348004	ABA4018	M.MARELLI	351746079000	ABA4071
KAVO PARTS	SSA-10197	ABA4077	KYB	339715	ABA4003	KYB	3348041	ABA4006	M.MARELLI	351772070000	ABA4035
KAVO PARTS	SSA-10198	ABA4078	KYB	339716	ABA4052	KYB	3348042	ABA4007	M.MARELLI	351781080000	ABA4036
KAVO PARTS	SSA10208	ABA4030	KYB	339717	ABA4053	KYB	3438002	ABA4005	M.MARELLI	351782080000	ABA4032
KAVO PARTS	SSA10209	ABA4027	KYB	339731	ABA4070	KYB	3448003	ABA4074	M.MARELLI	351890070000	ABA4074
KAVO PARTS	SSA10210	ABA4028	KYB	339732	ABA4070	KYB	3448032	ABA4064	M.MARELLI	351924070100	ABA4040
KAVO PARTS	SSA10215	ABA4038	KYB	339737	ABA4040	KYB	9337500	ABA4021	M.MARELLI	351925070000	ABA4008
KAVO PARTS	SSA10226	ABA4042	KYB	339739	ABA4040	KYB	9337501	ABA4020	M.MARELLI	351928070100	ABA4040
KAVO PARTS	SSA10269	ABA4011	KYB	339740	ABA4041	KYB	9347502	ABA4034	M.MARELLI	351928070200	ABA4041
KAVO PARTS	SSA-10270	ABA4068	KYB	339741	ABA4039	KYB	9430007	ABA4054	M.MARELLI	351929070000	ABA4033
KAVO PARTS	SSA10273	ABA4029	KYB	339756	ABA4044	KYB	9430019	ABA4071	M.MARELLI	351930070000	ABA4033
KAVO PARTS	SSA-10276	ABA4060	KYB	339757	ABA4045	LEXUS	485100H010	ABA4013	M.MARELLI	351931070000	ABA4008
KAVO PARTS	SSA10279	ABA4050	KYB	339763	ABA4039	LEXUS	485100H020	ABA4013	M.MARELLI	351932070000	ABA4034
KAVO PARTS	SSA10280	ABA4051	KYB	339771	ABA4072	LEXUS	485100H040	ABA4013	M.MARELLI	351932079000	ABA4034
KAVO PARTS	SSA10285	ABA4026	KYB	339772	ABA4073	LEXUS	485100H050	ABA4013	M.MARELLI	351935071000	ABA4035
KAVO PARTS	SSA10286	ABA4025	KYB	339788	ABA4058	LEXUS	485200H010	ABA4012	M.MARELLI	351938070100	ABA4019
KAVO PARTS	SSA-10306	ABA4074	KYB	339789	ABA4059	LEXUS	485200H020	ABA4012	M.MARELLI	351938070100	ABA4052
KAVO PARTS	SSA-10314	ABA4030	KYB	339808	ABA4067	LEXUS	485200H040	ABA4012	M.MARELLI	351938070200	ABA4018
KAVO PARTS	SSA-10340	ABA4072	KYB	339809	ABA4068	LEXUS	485200H050	ABA4012	M.MARELLI	351938070200	ABA4053
KAVO PARTS	SSA-10341	ABA4073	KYB	339850	ABA4056	LEXUS	485300H010	ABA4014	M.MARELLI	351938079100	ABA4019
KAVO PARTS	SSA-10346	ABA4074	KYB	339851	ABA4057	LEXUS	485300H030	ABA4014	M.MARELLI	351938079100	ABA4052
KAVO PARTS	SSA10437	ABA4006	KYB	339852	ABA4043	LEXUS	485300H041	ABA4014	M.MARELLI	351938079200	ABA4018
KAVO PARTS	SSA10438	ABA4007	KYB	339853	ABA4076	LEXUS	485300H050	ABA4014	M.MARELLI	351938079200	ABA4053
KAVO PARTS	SSA-10598	ABA4063	KYB	341189	ABA4032	LEXUS	485100D410	ABA4044	M.MARELLI	351942070000	ABA4004
KAVO PARTS	SSA-10637	ABA4048	KYB	341209	ABA4023	LEXUS	485100D430	ABA4044	M.MARELLI	351942079000	ABA4004
KAVO PARTS	SSA-10989	ABA4074	KYB	343328	ABA4054	LEXUS	485100D440	ABA4044	M.MARELLI	351947070100	ABA4021
KAVO PARTS	SSA-11381	ABA4077	KYB	343397	ABA4071	LEXUS	485100D830	ABA4044	M.MARELLI	351947070200	ABA4020
KAVO PARTS	SSA-11382	ABA4078	KYB	343415	ABA4008	LEXUS	485100D840	ABA4044	M.MARELLI	351947079100	ABA4021
KAVO PARTS	SSA9004	ABA4014	KYB	343459	ABA4004	LEXUS	485100D880	ABA4044	M.MARELLI	351947079200	ABA4020
KAVO PARTS	SSA9005	ABA4012	KYB	343488	ABA4015	LEXUS	485100D881	ABA4044	M.MARELLI	351950070000	ABA4070
KAVO PARTS	SSA9006	ABA4013	KYB	343808	ABA4014	LEXUS	485100D890	ABA4044	M.MARELLI	351950079000	ABA4070
KAVO PARTS	SSA9038	ABA4044	KYB	343823	ABA4046	LEXUS	485100DA20	ABA4044	M.MARELLI	351951070000	ABA4070
KAVO PARTS	SSA9039	ABA4045	KYB	343826	ABA4071	LEXUS	485100DA21	ABA4044	M.MARELLI	351953070100	ABA4017
KAVO PARTS	SSA9051	ABA4046	KYB	343828	ABA4035	LEXUS	485100DE70	ABA4044	M.MARELLI	351953070200	ABA4016
KYB	332807	ABA4013	KYB	344459	ABA4001	LEXUS	485100DE71	ABA4044	M.MARELLI	351954070000	ABA4071
KYB	332808	ABA4012	KYB	344665	ABA4055	LEXUS	485100DF00	ABA4044	M.MARELLI	351954079000	ABA4071
KYB	333744	ABA4038	KYB	344810	ABA4042	LEXUS	485100DF01	ABA4044	M.MARELLI	351955070000	ABA4071
KYB	333763	ABA4021	KYB	345078	ABA4074	LEXUS	485200D160	ABA4045	M.MARELLI	351957070000	ABA4015
KYB	333764	ABA4020	KYB	345079	ABA4074	LEXUS	485200D180	ABA4045	M.MARELLI	351958070100	ABA4040
KYB	333766	ABA4017	KYB	345700	ABA4065	LEXUS	485200D190	ABA4045	M.MARELLI	351970070000	ABA4015
KYB	333767	ABA4016	KYB	345701	ABA4065	LEXUS	485200D230	ABA4044	M.MARELLI	351973070000	ABA4064
KYB	333776	ABA4077	KYB	348005	ABA4033	LEXUS	485200D260	ABA4045	M.MARELLI	351974070000	ABA4064
KYB	333777	ABA4078	KYB	349019	ABA4024	LEXUS	485200D270	ABA4045	M.MARELLI	351975070100	ABA4067
KYB	333870	ABA4036	KYB	349041	ABA4049	LEXUS	485200D291	ABA4045	M.MARELLI	351975070200	ABA4068
KYB	333951	ABA4022	KYB	349145	ABA4069	LEXUS	485200D300	ABA4045	M.MARELLI	351976070000	ABA4033
KYB	334625	ABA4051	KYB	349148	ABA4060	LEXUS	485200D430	ABA4045	M.MARELLI	351978070000	ABA4069
KYB	334626	ABA4050	KYB	349149	ABA4060	LEXUS	485200D431	ABA4045	M.MARELLI	351978079000	ABA4069
KYB	334834	ABA4000	KYB	441077	ABA4023	LEXUS	485200D440	ABA4045	M.MARELLI	351984070100	ABA4057
KYB	334835	ABA4075	KYB	441098	ABA4032	LEXUS	485200D441	ABA4045	M.MARELLI	351984070200	ABA4056
KYB	334864	ABA4034	KYB	552700	ABA4054	LEXUS	485300D310	ABA4046	M.MARELLI	351987070000	ABA4071
KYB	334967	ABA4067	KYB	553340	ABA4037	LEXUS	485300D440	ABA4046	M.MARELLI	351998070000	ABA4066
KYB	334968	ABA4068	KYB	633731	ABA4036	LEXUS	485300D450	ABA4046	M.MARELLI	351999070000	ABA4066

M.MARELLI 352108070000 ABA4004	M.MARELLI 358055070100 ABA4006	MEYLE 40266230011 ABA4013	MONROE 251142RM ABA4001
M.MARELLI 352110070100 ABA4002	M.MARELLI 358055070200 ABA4007	MEYLE 40267250008 ABA4014	MONROE 251143RM ABA4054
M.MARELLI 352110070100 ABA4052	M.MARELLI 358082070100 ABA4019	MEYLE 11-26 623 0004 ABA4073	MONROE 251144RM ABA4054
M.MARELLI 352110070200 ABA4003	M.MARELLI 358082070100 ABA4052	MEYLE 11-26 623 0005 ABA4072	MONROE 251145RM ABA4054
M.MARELLI 352110070200 ABA4053	M.MARELLI 358082070200 ABA4018	MEYLE 11-26 623 0012 ABA4078	MONROE 251147RM ABA4054
M.MARELLI 352110070200 ABA4069	M.MARELLI 358082070200 ABA4053	MEYLE 11-26 623 0013 ABA4077	MONROE 251148RM ABA4014
M.MARELLI 352731070000 ABA4037	MERCEDES A1693201430 ABA4043	MEYLE 126 623 0004 ABA4075	MONROE 251149RM ABA4024
M.MARELLI 352738070000 ABA4043	MERCEDES A1693201630 ABA4043	MEYLE 226 613 0011 ABA4036	MONROE 251152RM ABA4005
M.MARELLI 352738070000 ABA4076	MERCEDES A1693260000 ABA4037	MEYLE 226 623 0017 ABA4064	MONROE 251153RM ABA4005
M.MARELLI 354311070000 ABA4075	MERCEDES A1693260200 ABA4037	MEYLE 226 623 0018 ABA4063	MONROE 251158RM ABA4066
M.MARELLI 354312070000 ABA4054	MERCEDES A1693260600 ABA4037	MEYLE 226 623 0019 ABA4070	MONROE 251159RM ABA4065
M.MARELLI 354318070000 ABA4000	MERCEDES A1693260700 ABA4037	MEYLE 226 623 0021 ABA4059	MONROE 251170RM ABA4069
M.MARELLI 354318070000 ABA4075	MERCEDES A1693260800 ABA4037	MEYLE 226 623 0022 ABA4058	MONROE 251176RM ABA4074
M.MARELLI 354318079000 ABA4000	MERCEDES A4513202331 ABA4047	MEYLE 226 725 0012 ABA4065	MONROE 251179RM ABA4060
M.MARELLI 354319070000 ABA4011	MERCEDES A4513202431 ABA4047	MEYLE 226 725 0013 ABA4065	MONROE 376001SP ABA4049
M.MARELLI 354319079000 ABA4011	MERCEDES A4513202531 ABA4048	MEYLE 226 725 0014 ABA4071	MONROE 376002SP ABA4049
M.MARELLI 354320070000 ABA4001	MERCEDES A4513202631 ABA4048	MEYLE 226 725 0015 ABA4060	MONROE 376027SP ABA4001
M.MARELLI 354320079000 ABA4001	MEYLE 0266230014 ABA4043	MEYLE 40-26 623 0013 ABA4068	MONROE 376052SP ABA4001
M.MARELLI 354322070000 ABA4039	MEYLE 0267250020 ABA4037	MEYLE 40-26 623 0014 ABA4067	MONROE 376053SP ABA4001
M.MARELLI 354324070000 ABA4039	MEYLE 0267250026 ABA4047	MEYLE 40-26 623 0019 ABA4072	MONROE 376082SP ABA4001
M.MARELLI 355805070000 ABA4055	MEYLE 1266230014 ABA4039	MEYLE 40-26 623 0020 ABA4073	MONROE 376099SP ABA4001
M.MARELLI 355806070000 ABA4005	MEYLE 1266230050 ABA4000	MEYLE 40-26 725 0007 ABA4069	MONROE 376108SP ABA4042
M.MARELLI 356229080000 ABA4038	MEYLE 1266230055 ABA4011	MEYLE 40-26 725 0011 ABA4074	MONROE 376130SP ABA4004
M.MARELLI 356320070100 ABA4013	MEYLE 1267250015 ABA4054	MEYLE 626 623 0016 ABA4053	MONROE 376224SP ABA4054
M.MARELLI 356320070200 ABA4012	MEYLE 1267250024 ABA4001	MEYLE 626 623 0017 ABA4052	MONROE 376225SP ABA4054
M.MARELLI 356321070000 ABA4014	MEYLE 1267250040 ABA4054	MEYLE 726 725 0035 ABA4005	MONROE 376227SP ABA4075
M.MARELLI 356501070000 ABA4042	MEYLE 2266130011 ABA4036	MONROE 10024 ABA4036	MONROE 376249SP ABA4004
M.MARELLI 356502070000 ABA4038	MEYLE 2266230002 ABA4034	MONROE 10053 ABA4036	MONROE 401001RM ABA4036
M.MARELLI 357065070000 ABA4074	MEYLE 2266230010 ABA4021	MONROE 11339 ABA4071	MONROE 401008RM ABA4034
M.MARELLI 357076070000 ABA4024	MEYLE 2266230011 ABA4020	MONROE 11340 ABA4071	MONROE 401037RM ABA4070
M.MARELLI 357083070100 ABA4051	MEYLE 2266230015 ABA4016	MONROE 16306 ABA4034	MONROE 401038RM ABA4036
M.MARELLI 357083070200 ABA4050	MEYLE 2266230016 ABA4017	MONROE 16381 ABA4021	MONROE 401076RM ABA4020
M.MARELLI 357094070000 ABA4060	MEYLE 2267150007 ABA4032	MONROE 16382 ABA4020	MONROE 401076RM ABA4021
M.MARELLI 357094070100 ABA4058	MEYLE 2267250004 ABA4035	MONROE 16451 ABA4000	MONROE 401077RM ABA4020
M.MARELLI 357094070200 ABA4059	MEYLE 2267250009 ABA4008	MONROE 16451 ABA4075	MONROE 401077RM ABA4021
M.MARELLI 357123070000 ABA4066	MEYLE 2267250010 ABA4015	MONROE 23473 ABA4035	MONROE 401083RM ABA4022
M.MARELLI 357128070000 ABA4065	MEYLE 3266230042 ABA4050	MONROE 23890 ABA4054	MONROE 401122RM ABA4038
M.MARELLI 357176070100 ABA4077	MEYLE 3266230043 ABA4051	MONROE 23925 ABA4054	MONROE 401126RM ABA4067
M.MARELLI 357176070200 ABA4078	MEYLE 3267250016 ABA4049	MONROE 23948 ABA4054	MONROE 401127RM ABA4068
M.MARELLI 357186070000 ABA4036	MEYLE 6266230016 ABA4003	MONROE 23950 ABA4054	MONROE 401132RM ABA4016
M.MARELLI 357187070000 ABA4022	MEYLE 6266230016 ABA4018	MONROE 23963 ABA4071	MONROE 401132RM ABA4017
M.MARELLI 357230070100 ABA4025	MEYLE 6266230016 ABA4053	MONROE 23977 ABA4008	MONROE 401133RM ABA4016
M.MARELLI 357230070200 ABA4026	MEYLE 6266230017 ABA4002	MONROE 23984 ABA4008	MONROE 401133RM ABA4017
M.MARELLI 357246070100 ABA4077	MEYLE 6266230017 ABA4019	MONROE 43130 ABA4037	MONROE 401134RM ABA4058
M.MARELLI 357246070200 ABA4078	MEYLE 6266230017 ABA4052	MONROE 43133 ABA4047	MONROE 401135RM ABA4059
M.MARELLI 357251070100 ABA4044	MEYLE 6267250015 ABA4004	MONROE 44001 ABA4005	MONROE 401136RM ABA4040
M.MARELLI 357251070200 ABA4045	MEYLE 7266230033 ABA4026	MONROE 251005RM ABA4032	MONROE 401137RM ABA4041
M.MARELLI 357254070100 ABA4073	MEYLE 7266230034 ABA4025	MONROE 251010RM ABA4035	MONROE 401138RM ABA4002
M.MARELLI 357254070200 ABA4072	MEYLE 7266230052 ABA4007	MONROE 251020RM ABA4032	MONROE 401138RM ABA4019
M.MARELLI 357261070000 ABA4076	MEYLE 7266230053 ABA4006	MONROE 251031RM ABA4071	MONROE 401138RM ABA4052
M.MARELLI 357326070000 ABA4046	MEYLE 7267250023 ABA4005	MONROE 251068RM ABA4008	MONROE 401139RM ABA4003
M.MARELLI 357367070000 ABA4060	MEYLE 11266230016 ABA4030	MONROE 251073RM ABA4046	MONROE 401139RM ABA4018
M.MARELLI 357432070000 ABA4047	MEYLE 11266230017 ABA4029	MONROE 251075RM ABA4023	MONROE 401139RM ABA4053
M.MARELLI 357479070000 ABA4074	MEYLE 11267250009 ABA4024	MONROE 251081RM ABA4033	MONROE 401140RM ABA4025
M.MARELLI 357506070100 ABA4029	MEYLE 11267250015 ABA4024	MONROE 251109RM ABA4015	MONROE 401141RM ABA4026
M.MARELLI 357506070200 ABA4030	MEYLE 16266230004 ABA4038	MONROE 251111RM ABA4008	MONROE 401146RM ABA4011
M.MARELLI 357507070100 ABA4027	MEYLE 16267250009 ABA4042	MONROE 251112RM ABA4004	MONROE 401147RM ABA4000
M.MARELLI 357507070200 ABA4028	MEYLE 40266230010 ABA4012	MONROE 251124RM ABA4042	MONROE 401148RM ABA4000

MONROE	401148RM ABA4075	MONROE	E7123 ABA4011	MONROE	G8174 ABA4040	NK	65103385 ABA4057
MONROE	401149RM ABA4054	MONROE	G1037 ABA4004	MONROE	G8175 ABA4041	NK	65103386 ABA4056
MONROE	401150RM ABA4012	MONROE	G1057 ABA4001	MONROE	G8208 ABA4058	NK	65193607 ABA4068
MONROE	401150RM ABA4013	MONROE	G1067 ABA4042	MONROE	G8209 ABA4059	NK	65193608 ABA4067
MONROE	401151RM ABA4012	MONROE	G1074 ABA4046	MONROE	G8213 ABA4050	NK	65193617 ABA4073
MONROE	401151RM ABA4013	MONROE	G1075 ABA4014	MONROE	G8221 ABA4029	NK	65193618 ABA4072
MONROE	401152RM ABA4077	MONROE	G1083 ABA4015	MONROE	G8222 ABA4030	NK	65193625 ABA4078
MONROE	401153RM ABA4078	MONROE	G1090 ABA4069	MONROE	G8223 ABA4027	NK	65193626 ABA4077
MONROE	401161RM ABA4000	MONROE	G1090A ABA4069	MONROE	G8224 ABA4028	NK	65233071 ABA4034
MONROE	401164RM ABA4064	MONROE	G1121 ABA4033	MONROE	G8264 ABA4011	NK	65233145 ABA4020
MONROE	401165RM ABA4063	MONROE	G1171 ABA4060	MONROE	G8288 ABA4006	NK	65233145 ABA4021
MONROE	401170RM ABA4011	MONROE	G1177 ABA4024	MONROE	G8288 ABA4007	NK	65233145 ABA4041
MONROE	401171RM ABA4054	MONROE	G1220 ABA4001	MONROE	G8289 ABA4006	NK	65233146 ABA4020
MONROE	401178RM ABA4077	MONROE	G1228 ABA4005	MONROE	G8289 ABA4007	NK	65233146 ABA4021
MONROE	401179RM ABA4078	MONROE	G1339 ABA4054	MONROE	G8292 ABA4051	NK	65233146 ABA4040
MONROE	401190RM ABA4073	MONROE	G1342 ABA4001	MONROE	G8293 ABA4050	NK	65233147 ABA4058
MONROE	401191RM ABA4072	MONROE	G1346 ABA4075	MONROE	G8312 ABA4057	NK	65233148 ABA4059
MONROE	742024SP ABA4076	MONROE	G1381 ABA4005	MONROE	G8313 ABA4056	NK	65233151 ABA4053
MONROE	742041SP ABA4050	MONROE	G16309 ABA4075	MONROE	G8313 ABA4057	NK	65233152 ABA4052
MONROE	742042SP ABA4075	MONROE	G16495 ABA4000	MONROE	G8398 ABA4000	NK	65233874 ABA4070
MONROE	742044SP ABA4039	MONROE	G16497 ABA4011	MONROE	G8399 ABA4011	NK	65253970 ABA4025
MONROE	742052SP ABA4000	MONROE	G2108 ABA4024	MONROE	R11038 ABA4022	NK	65253971 ABA4026
MONROE	742052SP ABA4075	MONROE	G2232 ABA4049	MONROE	R3216 ABA4052	NK	65253980 ABA4006
MONROE	742053SP ABA4043	MONROE	G2233 ABA4049	MONROE	R3420 ABA4023	NK	65253981 ABA4007
MONROE	742108SP ABA4002	MONROE	G2524 ABA4055	MONROE	R3441 ABA4032	NK	65331370 ABA4043
MONROE	742109SP ABA4003	MONROE	G7019 ABA4012	MONROE	R3472 ABA4032	NK	65331370 ABA4076
MONROE	742162SP ABA4077	MONROE	G7019 ABA4013	MONROE	R8001 ABA4072	NK	65373216 ABA4077
MONROE	742163SP ABA4078	MONROE	G7020 ABA4012	MONROE	R8002 ABA4073	NK	65373221 ABA4078
MONROE	742181SP ABA4077	MONROE	G7020 ABA4013	MONROE	V2131 ABA4066	NK	65373222 ABA4029
MONROE	742182SP ABA4077	MONROE	G7277 ABA4038	MONROE	V2132 ABA4065	NK	65373223 ABA4030
MONROE	742242SP ABA4011	MONROE	G7294 ABA4044	MONROE	V2517 ABA4074	NK	65373224 ABA4028
MONROE	742243SP ABA4000	MONROE	G7295 ABA4044	MONROE	V4512 ABA4064	NK	65373225 ABA4027
MONROE	742244SP ABA4000	MONROE	G7295 ABA4045	NK	6345100 ABA4014	NK	65393232 ABA4038
MONROE	742245SP ABA4011	MONROE	G7303 ABA4025	NK	60231057 ABA4032	NK	65393339 ABA4038
MONROE	742246SP ABA4000	MONROE	G7304 ABA4026	NK	60231148 ABA4032	NK	65433104 ABA4075
MONROE	742247SP ABA4011	MONROE	G7305 ABA4016	NK	60231723 ABA4023	NK	65473219 ABA4000
MONROE	742248SP ABA4000	MONROE	G7305 ABA4017	NK	62193438 ABA4064	NK	65473219 ABA4075
MONROE	742250SP ABA4000	MONROE	G7306 ABA4016	NK	62233062 ABA4036	NK	65473370 ABA4039
MONROE	742251SP ABA4011	MONROE	G7306 ABA4017	NK	63102375 ABA4055	NK	65473371 ABA4039
MONROE	742252SP ABA4011	MONROE	G7413 ABA4002	NK	63192086 ABA4074	NK	65473715 ABA4011
MONROE	742269SP ABA4000	MONROE	G7414 ABA4003	NK	63192467 ABA4065	NK	651531941 ABA4050
MONROE	742272SP ABA4002	MONROE	G8063 ABA4002	NK	63192469 ABA4065	NK	651531942 ABA4051
MONROE	742273SP ABA4003	MONROE	G8063 ABA4019	NK	63192472 ABA4069	NK	651533893 ABA4049
MONROE	D4479 ABA4052	MONROE	G8063 ABA4052	NK	63192475 ABA4074	NK	651930361 ABA4073
MONROE	D8008 ABA4071	MONROE	G8064 ABA4003	NK	63231217 ABA4071	NK	651930362 ABA4073
MONROE	E1274 ABA4054	MONROE	G8064 ABA4018	NK	63231238 ABA4054	NK	652331891 ABA4020
MONROE	E1307 ABA4071	MONROE	G8064 ABA4053	NK	63231268 ABA4008	NK	652331892 ABA4020
MONROE	E4008 ABA4036	MONROE	G8097 ABA4077	NK	63231525 ABA4015	NK	652331892 ABA4021
MONROE	E4031 ABA4036	MONROE	G8098 ABA4078	NK	63232789 ABA4060	NK	652332361 ABA4003
MONROE	E4713 ABA4075	MONROE	G8099 ABA4077	NK	63232790 ABA4060	NK	652332361 ABA4018
MONROE	E4997 ABA4075	MONROE	G8100 ABA4078	NK	63252757 ABA4005	NK	652332361 ABA4053
MONROE	E4998 ABA4075	MONROE	G8107 ABA4068	NK	63335626 ABA4037	NK	652332362 ABA4002
MONROE	E7052 ABA4000	MONROE	G8108 ABA4067	NK	63335629 ABA4047	NK	652332362 ABA4019
MONROE	E7070 ABA4050	MONROE	G8109 ABA4039	NK	63361322 ABA4004	NK	652332362 ABA4052
MONROE	E7070 ABA4051	MONROE	G8110 ABA4070	NK	63372371 ABA4024	NK	652333931 ABA4016
MONROE	E7086 ABA4077	MONROE	G8114 ABA4043	NK	63391418 ABA4042	NK	652333932 ABA4017
MONROE	E7090 ABA4070	MONROE	G8167 ABA4072	NK	63453210 ABA4046	NK	653034021 ABA4071
MONROE	E7099 ABA4076	MONROE	G8168 ABA4073	NK	63472194 ABA4001	NK	653732291 ABA4012

NK	653732292	ABA4013	OCAP	82320RU	ABA4008	OPEL	345090	ABA4002	OPENPARTS	SAB8049.32	ABA4015
NK	653732351	ABA4078	OCAP	82321FL	ABA4018	OPEL	345091	ABA4003	OPENPARTS	SAB8051.31	ABA4040
NK	653732352	ABA4077	OCAP	82321FL	ABA4053	OPEL	345092	ABA4002	OPENPARTS	SAB8052.31	ABA4040
NK	654533801	ABA4045	OCAP	82321FR	ABA4019	OPEL	436387	ABA4004	OPENPARTS	SAB8053.31	ABA4041
NK	654533802	ABA4044	OCAP	82321FR	ABA4052	OPEL	436388	ABA4004	OPENPARTS	SAB8068.31	ABA4070
NK	63231165	ABA4035	OCAP	82333FL	ABA4078	OPEL	436389	ABA4004	OPENPARTS	SAB8072.32	ABA4071
OCAP	82010RU	ABA4074	OCAP	82333FR	ABA4077	OPEL	436978	ABA4004	OPENPARTS	SAB8080.31	ABA4003
OCAP	82018RU	ABA4074	OCAP	82383FL	ABA4053	OPEL	436979	ABA4004	OPENPARTS	SAB8080.31	ABA4018
OCAP	82019RU	ABA4066	OCAP	82383FR	ABA4052	OPEL	13432671	ABA4004	OPENPARTS	SAB8085.32	ABA4054
OCAP	82020RU	ABA4065	OCAP	82385FL	ABA4050	OPEL	13432672	ABA4004	OPENPARTS	SAB8090.31	ABA4038
OCAP	82053RU	ABA4042	OCAP	82385FR	ABA4051	OPEL	13434131	ABA4003	OPENPARTS	SAB8092.11	ABA4038
OCAP	82054FU	ABA4038	OCAP	82477RU	ABA4071	OPEL	13434132	ABA4002	OPENPARTS	SAB8101.31	ABA4068
OCAP	82056FL	ABA4068	OCAP	82494FR	ABA4040	OPEL	13434133	ABA4003	OPENPARTS	SAB8104.31	ABA4064
OCAP	82056FR	ABA4067	OCAP	82505FL	ABA4056	OPEL	13434134	ABA4002	OPENPARTS	SAB8109.32	ABA4049
OCAP	82072RU	ABA4069	OCAP	82505FR	ABA4057	OPEL	13434137	ABA4003	OPENPARTS	SAB8155.32	ABA4042
OCAP	82073FU	ABA4064	OCAP	82531RU	ABA4005	OPEL	13434138	ABA4002	OPENPARTS	SAB8182.31	ABA4000
OCAP	82097FU	ABA4034	OCAP	82533FL	ABA4078	OPEL	13434139	ABA4003	OPENPARTS	SAB8202.32	ABA4024
OCAP	82098FU	ABA4022	OCAP	82533FR	ABA4077	OPEL	13434140	ABA4002	OPENPARTS	SAB8239.31	ABA4067
OCAP	82099RU	ABA4035	OCAP	82547FL	ABA4030	OPEL	93188949	ABA4003	OPENPARTS	SAB8251.31	ABA4043
OCAP	82103RU	ABA4023	OCAP	82547FR	ABA4029	OPEL	93188950	ABA4002	OPENPARTS	SAB8251.31	ABA4076
OCAP	82104FL	ABA4020	OCAP	82556FU	ABA4039	OPEL	93188953	ABA4053	OPENPARTS	SAB8270.32	ABA4069
OCAP	82104FR	ABA4021	OCAP	82560FL	ABA4007	OPEL	93188954	ABA4052	OPENPARTS	SAB8277.31	ABA4048
OCAP	82108RU	ABA4074	OCAP	82560FR	ABA4006	OPEL	93188956	ABA4003	OPENPARTS	SAB8291.31	ABA4051
OCAP	82109FU	ABA4036	OCAP	82578RU	ABA4054	OPEL	93188956	ABA4053	OPENPARTS	SAB8292.31	ABA4050
OCAP	82109RU	ABA4004	OCAP	82588FL	ABA4059	OPEL	93188957	ABA4003	OPENPARTS	SAB8299.31	ABA4059
OCAP	82113FU	ABA4075	OCAP	82588FR	ABA4058	OPEL	93188957	ABA4053	OPENPARTS	SAB8300.31	ABA4058
OCAP	82117RU	ABA4015	OCAP	82589RU	ABA4074	OPEL	93188958	ABA4052	OPENPARTS	SAB8305.31	ABA4013
OCAP	82118FL	ABA4016	OCAP	82626FU	ABA4048	OPEL	93189035	ABA4004	OPENPARTS	SAB8306.31	ABA4012
OCAP	82118FR	ABA4017	OCAP	82645FL	ABA4073	OPEL	93195845	ABA4003	OPENPARTS	SAB8307.32	ABA4014
OCAP	82119RU	ABA4032	OCAP	82645FR	ABA4072	OPEL	93195846	ABA4002	OPENPARTS	SAB8311.31	ABA4025
OCAP	82123RU	ABA4071	OCAP	82646FU	ABA4076	OPEL	95507189	ABA4003	OPENPARTS	SAB8312.31	ABA4026
OCAP	82129FU	ABA4011	OCAP	82650FL	ABA4028	OPEL	95507190	ABA4002	OPENPARTS	SAB8317.32	ABA4060
OCAP	82130RU	ABA4001	OCAP	82650FR	ABA4027	OPEL	95514590	ABA4003	OPENPARTS	SAB8330.32	ABA4074
OCAP	82131RU	ABA4054	OCAP	82693FU	ABA4070	OPEL	95514591	ABA4002	OPENPARTS	SAB8350.32	ABA4060
OCAP	82141FL	ABA4041	OCAP	82877FU	ABA4063	OPEL	95514592	ABA4003	OPENPARTS	SAB8359.31	ABA4078
OCAP	82141FR	ABA4040	OCAP	82889RU	ABA4008	OPEL	95514593	ABA4002	OPENPARTS	SAB8360.31	ABA4077
OCAP	82143FU	ABA4036	OPEL	344462	ABA4003	OPEL	95527308	ABA4004	OPENPARTS	SAB8361.32	ABA4047
OCAP	82152FU	ABA4070	OPEL	344463	ABA4002	OPENPARTS	SAB8001.31	ABA4034	OPENPARTS	SAB8384.31	ABA4002
OCAP	82163FU	ABA4000	OPEL	344616	ABA4003	OPENPARTS	SAB8002.32	ABA4035	OPENPARTS	SAB8385.31	ABA4003
OCAP	82170RU	ABA4037	OPEL	344617	ABA4002	OPENPARTS	SAB8003.32	ABA4004	OPENPARTS	SAB8392.31	ABA4053
OCAP	82172RU	ABA4024	OPEL	344654	ABA4003	OPENPARTS	SAB8008.32	ABA4008	OPENPARTS	SAB8393.31	ABA4052
OCAP	82181RU	ABA4060	OPEL	344655	ABA4002	OPENPARTS	SAB8009.31	ABA4020	OPENPARTS	SAB8417.31	ABA4078
OCAP	82193FL	ABA4012	OPEL	344659	ABA4053	OPENPARTS	SAB8010.31	ABA4021	OPENPARTS	SAB8418.31	ABA4077
OCAP	82193FR	ABA4013	OPEL	344660	ABA4052	OPENPARTS	SAB8013.31	ABA4016	OPENPARTS	SAB8498.32	ABA4066
OCAP	82218FL	ABA4026	OPEL	344661	ABA4003	OPENPARTS	SAB8016.31	ABA4017	OPENPARTS	SAB8501.31	ABA4052
OCAP	82218FR	ABA4025	OPEL	344662	ABA4003	OPENPARTS	SAB8017.11	ABA4036	OPENPARTS	SAB8502.31	ABA4053
OCAP	82230RU	ABA4049	OPEL	344662	ABA4053	OPENPARTS	SAB8019.32	ABA4032	OPENPARTS	SAB8519.31	ABA4039
OCAP	82259RU	ABA4060	OPEL	344663	ABA4053	OPENPARTS	SAB8022.31	ABA4002	OPENPARTS	SAB8523.31	ABA4039
OCAP	82260RU	ABA4014	OPEL	344664	ABA4052	OPENPARTS	SAB8022.31	ABA4019	OPENPARTS	SAB8524.31	ABA4072
OCAP	82285RU	ABA4047	OPEL	344899	ABA4003	OPENPARTS	SAB8023.11	ABA4022	OPENPARTS	SAB8525.31	ABA4073
OCAP	82299FU	ABA4043	OPEL	344901	ABA4002	OPENPARTS	SAB8025.12	ABA4032	OPENPARTS	SAB8540.31	ABA4039
OCAP	82299FU	ABA4076	OPEL	344903	ABA4003	OPENPARTS	SAB8026.31	ABA4036	OPENPARTS	SAB8541.31	ABA4063
OCAP	82304FU	ABA4039	OPEL	344904	ABA4002	OPENPARTS	SAB8029.31	ABA4075	OPENPARTS	SAB854431	ABA4056
OCAP	82306FL	ABA4003	OPEL	345083	ABA4003	OPENPARTS	SAB8030.31	ABA4011	OPENPARTS	SAB854531	ABA4057
OCAP	82306FR	ABA4002	OPEL	345084	ABA4002	OPENPARTS	SAB8031.32	ABA4023	OPENPARTS	SAB8546.32	ABA4055
OCAP	82311FL	ABA4045	OPEL	345085	ABA4003	OPENPARTS	SAB8032.32	ABA4001	OPENPARTS	SAB8549.31	ABA4027
OCAP	82311FR	ABA4044	OPEL	345086	ABA4002	OPENPARTS	SAB8033.12	ABA4023	OPENPARTS	SAB8550.31	ABA4028
OCAP	82312RU	ABA4046	OPEL	345089	ABA4003	OPENPARTS	SAB8042.32	ABA4037	OPENPARTS	SAB8552.32	ABA4033

OPENPARTS	SAB8600.31	ABA4029	OSRAV	FI345P/GL	ABA4074	OSRAV	PG055AS/GL	ABA4027	PSA	5206RK	ABA4024
OPENPARTS	SAB8601.31	ABA4030	OSRAV	FI346AD/GL	ABA4072	OSRAV	PG055AS/GL	ABA4028	PSA	B000674380	ABA4012
OSRAV	AB006P	ABA4023	OSRAV	FI346AS/GL	ABA4073	OSRAV	RN081A/GL	ABA4038	PSA	B000674480	ABA4013
OSRAV	AB006P/GL	ABA4023	OSRAV	FI346P/GL	ABA4074	OSRAV	RN081P/GL	ABA4042	PSA	B000674580	ABA4014
OSRAV	AR052AD/GL	ABA4057	OSRAV	FI347A/GL	ABA4070	OSRAV	SD003A/GL	ABA4075	PSA	B000771380	ABA4013
OSRAV	AR052AS/GL	ABA4056	OSRAV	FI347P/GL	ABA4071	OSRAV	SD003P/GL	ABA4054	PSA	B000771480	ABA4012
OSRAV	AR052P/GL	ABA4055	OSRAV	FI350AD/GL	ABA4067	OSRAV	SD004P/GL	ABA4054	PSA	B000869180	ABA4013
OSRAV	AU031A/GL	ABA4075	OSRAV	FI350AS/GL	ABA4068	OSRAV	SE016A/GL	ABA4039	PSA	B000869280	ABA4013
OSRAV	AU031P/GL	ABA4054	OSRAV	FI350P/GL	ABA4069	OSRAV	SE016P/GL	ABA4054	PSA	B000869380	ABA4012
OSRAV	BW056AD/GL	ABA4051	OSRAV	FI352AD/GL	ABA4058	OSRAV	TY043P/GL	ABA4046	PSA	B000869480	ABA4012
OSRAV	BW056AS/GL	ABA4050	OSRAV	FI352AS/GL	ABA4059	OSRAV	VW035A	ABA4075	PSA	B000869580	ABA4014
OSRAV	BW056P/GL	ABA4049	OSRAV	FI352P/GL	ABA4060	OSRAV	VW035A/GL	ABA4075	PSA	B000869680	ABA4014
OSRAV	BW059P/GL	ABA4049	OSRAV	FI353P/GL	ABA4004	OSRAV	VW035P/GL	ABA4054	PSA	B001049280	ABA4014
OSRAV	CI026AD/GL	ABA4073	OSRAV	FI360A/GL	ABA4064	OSRAV	VW036A/GL	ABA4011	RENAULT	8200382033	ABA4042
OSRAV	CI026AS/GL	ABA4073	OSRAV	FI361A/GL	ABA4063	OSRAV	VW036P/GL	ABA4001	RENAULT	8200452695	ABA4038
OSRAV	CI027AD/GL	ABA4013	OSRAV	FI362AD/GL	ABA4020	OSRAV	VW042A/GL	ABA4011	RENAULT	8200452699	ABA4042
OSRAV	CI027AS/GL	ABA4012	OSRAV	FI362AD/GL	ABA4021	OSRAV	VW042P/GL	ABA4001	RENAULT	8200676024	ABA4038
OSRAV	CI027P/GL	ABA4014	OSRAV	FI362AS/GL	ABA4020	PSA	1610852980	ABA4013	RENAULT	8200676026	ABA4038
OSRAV	FI048A	ABA4022	OSRAV	FI362AS/GL	ABA4021	PSA	1610853080	ABA4012	RENAULT	8200702469	ABA4042
OSRAV	FI048A/GL	ABA4022	OSRAV	FI364P/GL	ABA4069	PSA	1610864380	ABA4014	RENAULT	8200814535	ABA4038
OSRAV	FI077A	ABA4036	OSRAV	FI366AD/GL	ABA4018	PSA	1611852980	ABA4012	RENAULT	543022134R	ABA4038
OSRAV	FI077A/GL	ABA4036	OSRAV	FI366AD/GL	ABA4019	PSA	9678823080	ABA4024	RENAULT	562108573R	ABA4042
OSRAV	FI077P	ABA4032	OSRAV	FI366AD/GL	ABA4052	PSA	9678823180	ABA4024	SACHS	110026	ABA4022
OSRAV	FI077P/GL	ABA4032	OSRAV	FI366AD/GL	ABA4053	PSA	9801729080	ABA4030	SACHS	110778	ABA4023
OSRAV	FI324A/GL	ABA4034	OSRAV	FI366AS/GL	ABA4018	PSA	9801729180	ABA4029	SACHS	170492	ABA4036
OSRAV	FI324P/GL	ABA4035	OSRAV	FI366AS/GL	ABA4019	PSA	9801729280	ABA4030	SACHS	170493	ABA4036
OSRAV	FI330P/GL	ABA4071	OSRAV	FI366AS/GL	ABA4052	PSA	9801729380	ABA4029	SACHS	170494	ABA4032
OSRAV	FI335AD/GL	ABA4020	OSRAV	FI366AS/GL	ABA4053	PSA	9801729580	ABA4028	SACHS	170495	ABA4032
OSRAV	FI335AD/GL	ABA4021	OSRAV	FI367P/GL	ABA4060	PSA	9801729680	ABA4027	SACHS	170887	ABA4023
OSRAV	FI335AD/GL	ABA4040	OSRAV	FI368P/GL	ABA4033	PSA	9802145580	ABA4024	SACHS	200068	ABA4022
OSRAV	FI335AS/GL	ABA4020	OSRAV	FR081AD/GL	ABA4025	PSA	9803128680	ABA4024	SACHS	200460	ABA4073
OSRAV	FI335AS/GL	ABA4021	OSRAV	FR081AD/GL	ABA4026	PSA	9803520680	ABA4024	SACHS	200464	ABA4072
OSRAV	FI335AS/GL	ABA4040	OSRAV	FR081AS/GL	ABA4025	PSA	9804627180	ABA4024	SACHS	230545	ABA4036
OSRAV	FI335P/GL	ABA4008	OSRAV	FR081AS/GL	ABA4026	PSA	9804627280	ABA4024	SACHS	230546	ABA4032
OSRAV	FI336AD/GL	ABA4040	OSRAV	FR081P/GL	ABA4005	PSA	9804627380	ABA4024	SACHS	230549	ABA4036
OSRAV	FI336AD/GL	ABA4041	OSRAV	MR024A/GL	ABA4043	PSA	9804627480	ABA4024	SACHS	230550	ABA4032
OSRAV	FI336AS/GL	ABA4040	OSRAV	MR024A/GL	ABA4076	PSA	9804627580	ABA4024	SACHS	280371	ABA4034
OSRAV	FI336AS/GL	ABA4041	OSRAV	MR024P/GL	ABA4037	PSA	9804830980	ABA4030	SACHS	280372	ABA4034
OSRAV	FI336P/GL	ABA4033	OSRAV	MR037P/GL	ABA4037	PSA	9804831080	ABA4029	SACHS	280379	ABA4035
OSRAV	FI337AD/GL	ABA4018	OSRAV	OG057AD/GL	ABA4003	PSA	9804831180	ABA4029	SACHS	280380	ABA4035
OSRAV	FI337AD/GL	ABA4019	OSRAV	OG057AD/GL	ABA4052	PSA	9804831180	ABA4030	SACHS	280564	ABA4054
OSRAV	FI337AD/GL	ABA4052	OSRAV	OG057AD/GL	ABA4053	PSA	9804831280	ABA4029	SACHS	290853	ABA4036
OSRAV	FI337AD/GL	ABA4053	OSRAV	OG057AS/GL	ABA4003	PSA	9804831280	ABA4030	SACHS	290887	ABA4054
OSRAV	FI337AS/GL	ABA4018	OSRAV	OG057AS/GL	ABA4052	PSA	9810638780	ABA4024	SACHS	300032	ABA4075
OSRAV	FI337AS/GL	ABA4019	OSRAV	OG057AS/GL	ABA4053	PSA	9812825980	ABA4024	SACHS	300034	ABA4075
OSRAV	FI337AS/GL	ABA4052	OSRAV	OG057P/GL	ABA4004	PSA	9820310680	ABA4029	SACHS	310621	ABA4071
OSRAV	FI337AS/GL	ABA4053	OSRAV	OG066AD/GL	ABA4003	PSA	9820310680	ABA4030	SACHS	310715	ABA4001
OSRAV	FI337P/GL	ABA4004	OSRAV	OG066AS/GL	ABA4003	PSA	9820310780	ABA4029	SACHS	310950	ABA4001
OSRAV	FI341A/GL	ABA4064	OSRAV	PG046AD/GL	ABA4077	PSA	9820310780	ABA4030	SACHS	310984	ABA4049
OSRAV	FI341P/GL	ABA4065	OSRAV	PG046AS/GL	ABA4078	PSA	9820310880	ABA4029	SACHS	311007	ABA4001
OSRAV	FI342A/GL	ABA4063	OSRAV	PG046P/GL	ABA4024	PSA	9820310980	ABA4030	SACHS	311009	ABA4001
OSRAV	FI343P/GL	ABA4066	OSRAV	PG054AD/GL	ABA4029	PSA	9820324680	ABA4027	SACHS	311409	ABA4049
OSRAV	FI344AD/GL	ABA4017	OSRAV	PG054AD/GL	ABA4030	PSA	9820324780	ABA4028	SACHS	311421	ABA4008
OSRAV	FI344AS/GL	ABA4016	OSRAV	PG054AS/GL	ABA4029	PSA	5202RY	ABA4012	SACHS	311853	ABA4011
OSRAV	FI344AS/GL	ABA4017	OSRAV	PG054AS/GL	ABA4030	PSA	5202RZ	ABA4013	SACHS	311863	ABA4011
OSRAV	FI344P/GL	ABA4015	OSRAV	PG054P/GL	ABA4024	PSA	5202SE	ABA4012	SACHS	312266	ABA4011
OSRAV	FI345AD/GL	ABA4072	OSRAV	PG055AD/GL	ABA4027	PSA	5202SF	ABA4013	SACHS	312267	ABA4000
OSRAV	FI345AS/GL	ABA4073	OSRAV	PG055AD/GL	ABA4028	PSA	5206FE	ABA4024	SACHS	312451	ABA4021

SACHS	312452 ABA4020	SACHS	315132 ABA4069	SEVEN PARTS SV17A00014 ABA4016	SIDAT	F210G1585 ABA4076
SACHS	312594 ABA4075	SACHS	315241 ABA4026	SEVEN PARTS SV17A00016 ABA4018	SIDAT	F220G1299 ABA4069
SACHS	312615 ABA4011	SACHS	315242 ABA4025	SEVEN PARTS SV17A00016 ABA4053	SIDAT	F220G1301 ABA4060
SACHS	313015 ABA4076	SACHS	315293 ABA4076	SEVEN PARTS SV17A00020 ABA4071	SIDAT	F220G1310 ABA4066
SACHS	313033 ABA4072	SACHS	315372 ABA4059	SEVEN PARTS SV17A00025 ABA4033	SIDAT	F220G1312 ABA4065
SACHS	313053 ABA4011	SACHS	315373 ABA4058	SEVEN PARTS SV17A00028 ABA4070	SIDAT	F220G1348 ABA4071
SACHS	313231 ABA4042	SACHS	315374 ABA4060	SEVEN PARTS SV17A00029 ABA4038	SIDAT	F210G0362 ABA4050
SACHS	313362 ABA4011	SACHS	315377 ABA4033	SEVEN PARTS SV17A00033 ABA4054	SIDAT	F210G0363 ABA4051
SACHS	313472 ABA4011	SACHS	315449 ABA4078	SEVEN PARTS SV17A00036 ABA4039	SIDAT	F210G0364 ABA4020
SACHS	313473 ABA4001	SACHS	315450 ABA4077	SEVEN PARTS SV17A00037 ABA4060	SIDAT	F210G0365 ABA4021
SACHS	313552 ABA4018	SACHS	315453 ABA4024	SEVEN PARTS SV17A00049 ABA4040	SIDAT	F210G0376 ABA4019
SACHS	313552 ABA4053	SACHS	315459 ABA4073	SEVEN PARTS SV17A00050 ABA4041	SIDAT	F210G0376 ABA4052
SACHS	313566 ABA4003	SACHS	315460 ABA4072	SEVEN PARTS SV17A00051 ABA4026	SIDAT	F210G0377 ABA4018
SACHS	313568 ABA4002	SACHS	315463 ABA4060	SEVEN PARTS SV17A00053 ABA4025	SIDAT	F210G0377 ABA4053
SACHS	313571 ABA4004	SACHS	315740 ABA4056	SEVEN PARTS SV17A00057 ABA4013	SIDAT	F210G0606 ABA4038
SACHS	313573 ABA4004	SACHS	315741 ABA4057	SEVEN PARTS SV17A00058 ABA4067	SIDAT	F210G1099 ABA4013
SACHS	313671 ABA4078	SACHS	315742 ABA4055	SEVEN PARTS SV17A00059 ABA4068	SIDAT	F210G1100 ABA4012
SACHS	313673 ABA4077	SACHS	315866 ABA4007	SEVEN PARTS SV17A00068 ABA4012	SIDAT	F210G1121 ABA4044
SACHS	313679 ABA4078	SACHS	315867 ABA4006	SEVEN PARTS SV17A00069 ABA4076	SIDAT	F210G1122 ABA4045
SACHS	313681 ABA4077	SACHS	315868 ABA4005	SEVEN PARTS SV17A00070 ABA4043	SIDAT	F210G1417 ABA4036
SACHS	313683 ABA4024	SACHS	315873 ABA4019	SEVEN PARTS SV17A00071 ABA4037	SIDAT	F210G1418 ABA4036
SACHS	313911 ABA4021	SACHS	315873 ABA4052	SEVEN PARTS SV17A00073 ABA4075	SIDAT	F210G1420 ABA4022
SACHS	313912 ABA4020	SACHS	315874 ABA4030	SEVEN PARTS SV17A00079 ABA4000	SIDAT	F210G1423 ABA4034
SACHS	313962 ABA4004	SACHS	315875 ABA4029	SEVEN PARTS SV17A00083 ABA4014	SIDAT	F210G1427 ABA4025
SACHS	313990 ABA4070	SACHS	315876 ABA4028	SEVEN PARTS SV17A00084 ABA4001	SIDAT	F210G1428 ABA4026
SACHS	313991 ABA4071	SACHS	315877 ABA4027	SEVEN PARTS SV17A00085 ABA4011	SIDAT	F210G1433 ABA4038
SACHS	313993 ABA4017	SACHS	316893 ABA4045	SEVEN PARTS SV17A00112 ABA4058	SIDAT	F210G1445 ABA4000
SACHS	313996 ABA4040	SACHS	316896 ABA4005	SEVEN PARTS SV17A00113 ABA4059	SIDAT	F210G1451 ABA4039
SACHS	313997 ABA4041	SACHS	316991 ABA4054	SEVEN PARTS SV17A00115 ABA4063	SIDAT	F210G1452 ABA4017
SACHS	314011 ABA4011	SACHS	317337 ABA4037	SEVEN PARTS SV17A00116 ABA4064	SIDAT	F210G1453 ABA4016
SACHS	314032 ABA4073	SACHS	317346 ABA4054	SEVEN PARTS SV17A00122 ABA4069	SIDAT	F210G1454 ABA4011
SACHS	314033 ABA4072	SACHS	317495 ABA4003	SEVEN PARTS SV17A00123 ABA4032	SIDAT	F210G1455 ABA4043
SACHS	314134 ABA4021	SACHS	317496 ABA4002	SEVEN PARTS SV17A00124 ABA4032	SIDAT	F210G1456 ABA4040
SACHS	314135 ABA4020	SACHS	317510 ABA4046	SEVEN PARTS SV17A00126 ABA4005	SIDAT	F210G1457 ABA4041
SACHS	314572 ABA4063	SACHS	317568 ABA4051	SEVEN PARTS SV17A00159 ABA4042	SIDAT	F210G1485 ABA4052
SACHS	314623 ABA4070	SACHS	317569 ABA4050	SEVEN PARTS SV17A00172 ABA4047	SIDAT	F210G1486 ABA4053
SACHS	314627 ABA4070	SACHS	317572 ABA4011	SEVEN PARTS SV17A00178 ABA4046	SIDAT	F210G1557 ABA4029
SACHS	314630 ABA4012	SACHS	317573 ABA4011	SEVEN PARTS SV17A00187 ABA4012	SIDAT	F210G1558 ABA4030
SACHS	314631 ABA4013	SACHS	317574 ABA4011	SEVEN PARTS SV17A00188 ABA4013	SIDAT	F210G1586 ABA4027
SACHS	314632 ABA4014	SACHS	317575 ABA4011	SEVEN PARTS SV17A00216 ABA4050	SIDAT	F210G1587 ABA4028
SACHS	314663 ABA4074	SACHS	317577 ABA4011	SEVEN PARTS SV17A00217 ABA4051	SIDAT	F210G1593 ABA4057
SACHS	314708 ABA4064	SACHS	317578 ABA4011	SEVEN PARTS SV17A00243 ABA4077	SIDAT	F210G1594 ABA4056
SACHS	314711 ABA4065	SACHS	317579 ABA4011	SEVEN PARTS SV17A00244 ABA4078	SIDAT	F220G0361 ABA4049
SACHS	314715 ABA4066	SACHS	317645 ABA4075	SEVEN PARTS SV17A00251 ABA4037	SIDAT	F220G0366 ABA4008
SACHS	314717 ABA4039	SACHS	317969 ABA4015	SEVEN PARTS SV17A00253 ABA4044	SIDAT	F220G0375 ABA4004
SACHS	314736 ABA4038	SACHS	318008 ABA4044	SEVEN PARTS SV17A00254 ABA4045	SIDAT	F220G1039 ABA4014
SACHS	314753 ABA4071	SACHS	319577 ABA4047	SEVEN PARTS SV17A00262 ABA4056	SIDAT	F220G1240 ABA4032
SACHS	314839 ABA4016	SACHS	400019 ABA4001	SEVEN PARTS SV17A00268 ABA4029	SIDAT	F220G1256 ABA4015
SACHS	314840 ABA4017	SACHS	400064 ABA4003	SEVEN PARTS SVI9937C1 ABA4057	SIDAT	F220G1260 ABA4023
SACHS	314843 ABA4015	SEVEN PARTS SV17A00001 ABA4034	SIDAT	F210G0586 ABA4073	SIDAT	F220G1265 ABA4033
SACHS	314868 ABA4004	SEVEN PARTS SV17A00003 ABA4022	SIDAT	F210G0587 ABA4072	SIDAT	F220G1277 ABA4032
SACHS	314871 ABA4057	SEVEN PARTS SV17A00004 ABA4004	SIDAT	F210G1439 ABA4075	SIDAT	F220G1285 ABA4024
SACHS	314883 ABA4011	SEVEN PARTS SV17A00007 ABA4015	SIDAT	F210G1458 ABA4070	SIDAT	F220G1323 ABA4035
SACHS	315091 ABA4011	SEVEN PARTS SV17A00008 ABA4033	SIDAT	F210G1467 ABA4064	SIDAT	F220G1343 ABA4054
SACHS	315123 ABA4068	SEVEN PARTS SV17A00009 ABA4023	SIDAT	F210G1548 ABA4058	SIDAT	F220G1360 ABA4005
SACHS	315124 ABA4067	SEVEN PARTS SV17A00011 ABA4021	SIDAT	F210G1549 ABA4059	SIDAT	F220G1364 ABA4037
SACHS	315125 ABA4068	SEVEN PARTS SV17A00012 ABA4017	SIDAT	F210G1575 ABA4077	SIDAT	F220G1378 ABA4001
SACHS	315126 ABA4067	SEVEN PARTS SV17A00013 ABA4020	SIDAT	F210G1576 ABA4078	SIDAT	F220G1389 ABA4047

SIDAT	F220G1391	ABA4042	STARLINE	TL5000112	ABA4000	TRW	JGM1010T	ABA4043	TRW	JGM1297SL	ABA4073
SIDAT	F220G1394	ABA4055	STARLINE	TLST0189	ABA4020	TRW	JGM1010T	ABA4076	TRW	JGM1297SR	ABA4072
STARLINE	TL A31035.2	ABA4036	STARLINE	TLST0189	ABA4041	TRW	JGM1019SL	ABA4078	TRW	JGM1297T	ABA4072
STARLINE	TL C00034.2	ABA4004	STARLINE	TLST02622	ABA4011	TRW	JGM1019SR	ABA4077	TRW	JGM1297T	ABA4073
STARLINE	TL C00163/4	ABA4020	STARLINE	TLST0290	ABA4012	TRW	JGM1019T	ABA4077	TRW	JGM1345SL	ABA4029
STARLINE	TL C00181.2	ABA4071	STARLINE	TLST0290	ABA4013	TRW	JGM1019T	ABA4078	TRW	JGM1345SL	ABA4030
STARLINE	TL C00188.2	ABA4033	STARLINE	TLST0312	ABA4038	TRW	JGM1030S	ABA4011	TRW	JGM1345SR	ABA4029
STARLINE	TL C00192.2	ABA4001	STARLINE	TLST0412	ABA4016	TRW	JGM1030T	ABA4011	TRW	JGM1345SR	ABA4030
STARLINE	TL C00325.2	ABA4070	STARLINE	TLST0412	ABA4017	TRW	JGM1032S	ABA4011	TRW	JGM1345T	ABA4029
STARLINE	TL C00339.2	ABA4069	STARLINE	TLST0592	ABA4054	TRW	JGM1032T	ABA4011	TRW	JGM1345T	ABA4030
STARLINE	TL C00340.2	ABA4005	STARLINE	TLST0692	ABA4001	TRW	JGM1034S	ABA4011	TRW	JGM1349SR	ABA4002
STARLINE	TL C00341.2	ABA4042	STARLINE	TLST0702	ABA4001	TRW	JGM1034T	ABA4011	TRW	JGM1351SR	ABA4002
STARLINE	TL C00342/3	ABA4026	STARLINE	TLST0722	ABA4033	TRW	JGM1036S	ABA4011	TRW	JGM1357SL	ABA4044
STARLINE	TL C00347.2	ABA4047	TOYOTA	485100D410	ABA4044	TRW	JGM1036T	ABA4011	TRW	JGM1357SL	ABA4045
STARLINE	TL C00348/9	ABA4058	TOYOTA	485100D430	ABA4044	TRW	JGM1046S	ABA4071	TRW	JGM1357SR	ABA4044
STARLINE	TL C00348/9	ABA4059	TOYOTA	485100D440	ABA4044	TRW	JGM1046T	ABA4071	TRW	JGM1357SR	ABA4045
STARLINE	TL C00353.2	ABA4060	TOYOTA	485100D830	ABA4044	TRW	JGM1050S	ABA4064	TRW	JGM1357T	ABA4044
STARLINE	TL C00403/4	ABA4077	TOYOTA	485100D840	ABA4044	TRW	JGM1050T	ABA4064	TRW	JGM1357T	ABA4045
STARLINE	TL C00403/4	ABA4078	TOYOTA	485100D880	ABA4044	TRW	JGM1058S	ABA4011	TRW	JGM1367SL	ABA4059
STARLINE	TL C00416/7	ABA4006	TOYOTA	485100D881	ABA4044	TRW	JGM1058T	ABA4011	TRW	JGM1367SR	ABA4058
STARLINE	TL C00426/7	ABA4029	TOYOTA	485100D890	ABA4044	TRW	JGM1072S	ABA4076	TRW	JGM1367ST	ABA4058
STARLINE	TL D27341/2	ABA4044	TOYOTA	485100DA20	ABA4044	TRW	JGM1072T	ABA4076	TRW	JGM1367ST	ABA4059
STARLINE	TL S00002.2	ABA4054	TOYOTA	485100DA21	ABA4044	TRW	JGM1082S	ABA4039	TRW	JGM136S	ABA4075
STARLINE	TL S00002.2	ABA4075	TOYOTA	485100DE70	ABA4044	TRW	JGM1082T	ABA4039	TRW	JGM136T	ABA4075
STARLINE	TL S00004.2	ABA4054	TOYOTA	485100DE71	ABA4044	TRW	JGM1091SL	ABA4025	TRW	JGM266S	ABA4036
STARLINE	TL S00005.2	ABA4054	TOYOTA	485100DF00	ABA4044	TRW	JGM1091SL	ABA4026	TRW	JGM266T	ABA4036
STARLINE	TL S00006.2	ABA4054	TOYOTA	485100DF01	ABA4044	TRW	JGM1091SR	ABA4025	TRW	JGM271S	ABA4034
STARLINE	TL S00008.2	ABA4000	TOYOTA	485100H010	ABA4013	TRW	JGM1091SR	ABA4026	TRW	JGM271T	ABA4034
STARLINE	TL ST018/9	ABA4040	TOYOTA	485100H020	ABA4013	TRW	JGM1091T	ABA4025	TRW	JGM306S	ABA4075
STARLINE	TL ST0262.2	ABA4000	TOYOTA	485100H040	ABA4013	TRW	JGM1091T	ABA4026	TRW	JGM306T	ABA4075
STARLINE	TL ST027/8	ABA4019	TOYOTA	485100H050	ABA4013	TRW	JGM1127SL	ABA4050	TRW	JGM307S	ABA4075
STARLINE	TL ST027/8	ABA4052	TOYOTA	485200D160	ABA4045	TRW	JGM1127SL	ABA4051	TRW	JGM307T	ABA4075
STARLINE	TL ST043/4	ABA4072	TOYOTA	485200D180	ABA4045	TRW	JGM1127SR	ABA4050	TRW	JGM349S	ABA4075
STARLINE	TL ST043/4	ABA4073	TOYOTA	485200D190	ABA4045	TRW	JGM1127SR	ABA4051	TRW	JGM349T	ABA4075
STARLINE	TL ST046/7	ABA4067	TOYOTA	485200D230	ABA4044	TRW	JGM1127T	ABA4050	TRW	JGM360S	ABA4071
STARLINE	TL ST046/7	ABA4068	TOYOTA	485200D260	ABA4045	TRW	JGM1127T	ABA4051	TRW	JGM360T	ABA4071
STARLINE	TL ST051.2	ABA4064	TOYOTA	485200D270	ABA4045	TRW	JGM1129SL	ABA4050	TRW	JGM5967SL	ABA4020
STARLINE	TL ST052.2	ABA4063	TOYOTA	485200D291	ABA4045	TRW	JGM1129SL	ABA4051	TRW	JGM5967SL	ABA4021
STARLINE	TL ST059.2	ABA4054	TOYOTA	485200D300	ABA4045	TRW	JGM1129SR	ABA4050	TRW	JGM5967SR	ABA4020
STARLINE	TL ST091.2	ABA4076	TOYOTA	485200D430	ABA4045	TRW	JGM1129SR	ABA4051	TRW	JGM5967SR	ABA4021
STARLINE	TLA000082	ABA4023	TOYOTA	485200D431	ABA4045	TRW	JGM1129T	ABA4050	TRW	JGM5967T	ABA4020
STARLINE	TLA000352	ABA4032	TOYOTA	485200D440	ABA4045	TRW	JGM1129T	ABA4051	TRW	JGM5967T	ABA4021
STARLINE	TLA310012	ABA4022	TOYOTA	485200D441	ABA4045	TRW	JGM1133SL	ABA4050	TRW	JGM6112SL	ABA4020
STARLINE	TLC000302	ABA4035	TOYOTA	485200H010	ABA4012	TRW	JGM1133SL	ABA4051	TRW	JGM6112SL	ABA4021
STARLINE	TLC000312	ABA4034	TOYOTA	485200H020	ABA4012	TRW	JGM1133SR	ABA4050	TRW	JGM6112SR	ABA4020
STARLINE	TLC001634	ABA4021	TOYOTA	485200H040	ABA4012	TRW	JGM1133SR	ABA4051	TRW	JGM6112SR	ABA4021
STARLINE	TLC001882	ABA4008	TOYOTA	485200H050	ABA4012	TRW	JGM1133T	ABA4050	TRW	JGM6112T	ABA4020
STARLINE	TLC001932	ABA4004	TOYOTA	485300D310	ABA4046	TRW	JGM1133T	ABA4051	TRW	JGM6112T	ABA4021
STARLINE	TLC002656	ABA4050	TOYOTA	485300D440	ABA4046	TRW	JGM1144S	ABA4070	TRW	JGM6212SL	ABA4012
STARLINE	TLC003132	ABA4024	TOYOTA	485300D450	ABA4046	TRW	JGM1144T	ABA4070	TRW	JGM6212SL	ABA4013
STARLINE	TLC003272	ABA4039	TOYOTA	485300H010	ABA4014	TRW	JGM1148S	ABA4063	TRW	JGM6212SR	ABA4012
STARLINE	TLC003423	ABA4025	TOYOTA	485300H030	ABA4014	TRW	JGM1148T	ABA4063	TRW	JGM6212SR	ABA4013
STARLINE	TLC003862	ABA4015	TOYOTA	485300H041	ABA4014	TRW	JGM1207SL	ABA4016	TRW	JGM6212T	ABA4012
STARLINE	TLC004167	ABA4007	TOYOTA	485300H050	ABA4014	TRW	JGM1207SL	ABA4017	TRW	JGM6212T	ABA4013
STARLINE	TLC004267	ABA4030	TRW	JGE191S	ABA4004	TRW	JGM1207SR	ABA4016	TRW	JGM627S	ABA4071
STARLINE	TLS000042	ABA4054	TRW	JGE191T	ABA4004	TRW	JGM1207SR	ABA4017	TRW	JGM627T	ABA4071
STARLINE	TLS000082	ABA4011	TRW	JGM1010S	ABA4043	TRW	JGM1207T	ABA4016	TRW	JGM633T	ABA4011
STARLINE	TLS000092	ABA4001	TRW	JGM1010S	ABA4076	TRW	JGM1207T	ABA4017	TRW	JGM634S	ABA4011

TRW	JGM634T ABA4011	TRW	JGT1082T ABA4054	TRW	JGT584T ABA4069	VAG	1K0513029CF ABA4001
TRW	JGM6456SL ABA4018	TRW	JGT1090S ABA4024	TRW	JGT585S ABA4004	VAG	1K0513029CK ABA4001
TRW	JGM6456SL ABA4019	TRW	JGT1090T ABA4024	TRW	JGT585T ABA4004	VAG	1K0513029CM ABA4001
TRW	JGM6456SL ABA4052	TRW	JGT1106S ABA4005	TRW	JGT589S ABA4001	VAG	1K0513029CQ ABA4001
TRW	JGM6456SR ABA4018	TRW	JGT1106T ABA4005	TRW	JGT589T ABA4001	VAG	1K0513029CR ABA4001
TRW	JGM6456SR ABA4019	TRW	JGT1108T ABA4049	TRW	JGT591S ABA4069	VAG	1K0513029DS ABA4001
TRW	JGM6456SR ABA4052	TRW	JGT1148S ABA4055	TRW	JGT591T ABA4069	VAG	1K0513029ED ABA4001
TRW	JGM6456T ABA4018	TRW	JGT1148T ABA4055	TRW	JHM266S ABA4036	VAG	1K0513029EN ABA4001
TRW	JGM6456T ABA4019	TRW	JGT1158S ABA4065	TRW	JHM266T ABA4036	VAG	1K0513029EP ABA4001
TRW	JGM6456T ABA4052	TRW	JGT1158T ABA4065	TRW	JHM3189SL ABA4073	VAG	1K0513029ER ABA4001
TRW	JGM6490SL ABA4003	TRW	JGT1160S ABA4065	TRW	JHM3189SR ABA4073	VAG	1K0513029FA ABA4001
TRW	JGM6490SR ABA4003	TRW	JGT1160T ABA4065	TRW	JHM3189T ABA4073	VAG	1K0513029FB ABA4001
TRW	JGM6490T ABA4003	TRW	JGT1162S ABA4066	TRW	JHM402S ABA4022	VAG	1K0513029FG ABA4001
TRW	JGM6512SL ABA4052	TRW	JGT1162T ABA4066	TRW	JHM402T ABA4022	VAG	1K0513029FH ABA4001
TRW	JGM6512SL ABA4053	TRW	JGT1168S ABA4049	TRW	JHM655S ABA4038	VAG	1K0513029FK ABA4001
TRW	JGM6512SR ABA4053	TRW	JGT1350S ABA4060	TRW	JHM655T ABA4038	VAG	1K0513029FM ABA4001
TRW	JGM6512T ABA4052	TRW	JGT1350T ABA4060	TRW	JHT180S ABA4023	VAG	1K0513029FT ABA4001
TRW	JGM6512T ABA4053	TRW	JGT267S ABA4054	TRW	JHT180T ABA4023	VAG	1K0513029GF ABA4001
TRW	JGM6878SL ABA4003	TRW	JGT267T ABA4054	TRW	JHT202S ABA4032	VAG	1K0513029GG ABA4001
TRW	JGM6878SL ABA4052	TRW	JGT277S ABA4071	TRW	JHT202T ABA4032	VAG	1K0513029GH ABA4001
TRW	JGM6878SL ABA4053	TRW	JGT277T ABA4071	TRW	JHT418S ABA4008	VAG	1K0513029GP ABA4001
TRW	JGM6878SR ABA4003	TRW	JGT282S ABA4035	TRW	JHT418T ABA4008	VAG	1K0513029HA ABA4001
TRW	JGM6878SR ABA4052	TRW	JGT282T ABA4035	VAG	3938673 ABA4022	VAG	1K0513029HF ABA4001
TRW	JGM6878SR ABA4053	TRW	JGT388S ABA4032	VAG	3938673 ABA4023	VAG	1K0513029HJ ABA4001
TRW	JGM6878T ABA4003	TRW	JGT388T ABA4032	VAG	561513049 ABA4001	VAG	1K0513029HK ABA4001
TRW	JGM6878T ABA4052	TRW	JGT429S ABA4001	VAG	1K0413031AC ABA4000	VAG	1K0513029HL ABA4001
TRW	JGM6878T ABA4053	TRW	JGT429T ABA4001	VAG	1K0413031AD ABA4000	VAG	1K0513029HM ABA4001
TRW	JGM765S ABA4000	TRW	JGT430S ABA4001	VAG	1K0413031AE ABA4000	VAG	1K0513029HN ABA4001
TRW	JGM765S ABA4075	TRW	JGT430T ABA4001	VAG	1K0413031AF ABA4000	VAG	1K0513029HP ABA4001
TRW	JGM765T ABA4000	TRW	JGT446S ABA4014	VAG	1K0413031AH ABA4000	VAG	1K0513029HQ ABA4001
TRW	JGM765T ABA4075	TRW	JGT446T ABA4014	VAG	1K0413031AJ ABA4000	VAG	1K0513029HR ABA4001
TRW	JGM766S ABA4075	TRW	JGT448S ABA4001	VAG	1K0413031AQ ABA4000	VAG	1K0513029JD ABA4001
TRW	JGM766T ABA4075	TRW	JGT448T ABA4001	VAG	1K0413031AS ABA4000	VAG	1K0513029JF ABA4001
TRW	JGM771S ABA4000	TRW	JGT452S ABA4033	VAG	1K0413031AT ABA4000	VAG	1K0513029JG ABA4001
TRW	JGM771T ABA4000	TRW	JGT452T ABA4033	VAG	1K0413031BA ABA4000	VAG	1K0513029MB ABA4001
TRW	JGM7789SL ABA4068	TRW	JGT471S ABA4004	VAG	1K0413031BE ABA4000	VAG	1K0513029MC ABA4001
TRW	JGM7789SR ABA4067	TRW	JGT471T ABA4004	VAG	1K0413031BF ABA4000	VAG	1K0513029MD ABA4001
TRW	JGM7789T ABA4067	TRW	JGT476S ABA4001	VAG	1K0413031BG ABA4000	VAG	1K0513029ME ABA4001
TRW	JGM7789T ABA4068	TRW	JGT476T ABA4001	VAG	1K0413031BH ABA4000	VAG	1K0513029MF ABA4001
TRW	JGM7801SL ABA4068	TRW	JGT483S ABA4042	VAG	1K0413031BJ ABA4000	VAG	1K0513029MG ABA4001
TRW	JGM7801SR ABA4067	TRW	JGT483T ABA4042	VAG	1K0413031BK ABA4000	VAG	1K0513029MK ABA4001
TRW	JGM7801T ABA4067	TRW	JGT546S ABA4004	VAG	1K0413031BL ABA4000	VAG	1K0513029ML ABA4001
TRW	JGM7801T ABA4068	TRW	JGT546T ABA4004	VAG	1K0413031BS ABA4000	VAG	1K0513029MR ABA4001
TRW	JGM786S ABA4000	TRW	JGT555S ABA4042	VAG	1K0413031BT ABA4000	VAG	1K0513029NC ABA4001
TRW	JGM786T ABA4000	TRW	JGT555T ABA4042	VAG	1K0413031CA ABA4000	VAG	1K0513029ND ABA4001
TRW	JGM7934SL ABA4078	TRW	JGT573S ABA4024	VAG	1K0413031CN ABA4000	VAG	1K0513029NG ABA4001
TRW	JGM7934SR ABA4077	TRW	JGT573T ABA4024	VAG	1K0413031CP ABA4000	VAG	1K0513029NH ABA4001
TRW	JGM7934T ABA4077	TRW	JGT574S ABA4024	VAG	1K0413031CT ABA4000	VAG	1K0513029NJ ABA4001
TRW	JGM7934T ABA4078	TRW	JGT574T ABA4024	VAG	1K0413031DA ABA4000	VAG	1K0513029NN ABA4001
TRW	JGM830S ABA4000	TRW	JGT575S ABA4074	VAG	1K0413031DE ABA4000	VAG	1K0513029NP ABA4001
TRW	JGM830T ABA4000	TRW	JGT575T ABA4074	VAG	1K0413031DF ABA4000	VAG	1K0513029NQ ABA4001
TRW	JGT1054S ABA4001	TRW	JGT576S ABA4074	VAG	1K0413031DG ABA4000	VAG	1T041031EK ABA4011
TRW	JGT1054T ABA4001	TRW	JGT576T ABA4074	VAG	1K0413031DJ ABA4000	VAG	1T041031BH ABA4011
TRW	JGT1062S ABA4037	TRW	JGT578S ABA4001	VAG	1K0413031DK ABA4000	VAG	1T041031BP ABA4011
TRW	JGT1062T ABA4037	TRW	JGT578T ABA4001	VAG	1K0413031DL ABA4000	VAG	1T041031BQ ABA4011
TRW	JGT1078S ABA4054	TRW	JGT583S ABA4015	VAG	1K0513029CA ABA4001	VAG	1T041031BR ABA4011
TRW	JGT1078T ABA4054	TRW	JGT583T ABA4015	VAG	1K0513029CB ABA4001	VAG	1T041031BS ABA4011
TRW	JGT1082S ABA4054	TRW	JGT584S ABA4069	VAG	1K0513029CE ABA4001	VAG	1T041031BT ABA4011

VAG	1T0413031CE	ABA4011	VAG	3AA413031H	ABA4011	VAG	5C0413031BP	ABA4011	VAG	SE028156615A	ABA4022
VAG	1T0413031CF	ABA4011	VAG	3AA413031J	ABA4011	VAG	5C0413031BR	ABA4000	VAG	SE028156615A	ABA4023
VAG	1T0413031CJ	ABA4011	VAG	3AA413031M	ABA4011	VAG	5C0413031CS	ABA4011	VAG	SE141156220A	ABA4022
VAG	1T0413031CK	ABA4011	VAG	3AA513049	ABA4001	VAG	5C0413031CT	ABA4011	VAICO	V10-4249	ABA4000
VAG	1T0413031CL	ABA4011	VAG	3AA513049A	ABA4001	VAG	5C0413031DG	ABA4011	VAICO	V10-4250	ABA4001
VAG	1T0413031CM	ABA4011	VAG	3AA513049B	ABA4001	VAG	5C0413031E	ABA4011	VAICO	V10-4254	ABA4011
VAG	1T0413031CN	ABA4011	VAG	3AA513049C	ABA4001	VAG	5C0413031J	ABA4000	VAICO	V10-4256	ABA4001
VAG	1T0413031CP	ABA4011	VAG	3AA513049D	ABA4001	VAG	5C0413031M	ABA4011	VAICO	V10-4955	ABA4011
VAG	1T0413031CS	ABA4011	VAG	3C0413031AB	ABA4011	VAG	5C0413031T	ABA4011	VAICO	V10-4978	ABA4001
VAG	1T0413031DA	ABA4011	VAG	3C0413031AH	ABA4011	VAG	5C0513025J	ABA4001	VAICO	V10-5445	ABA4001
VAG	1T0413031DB	ABA4011	VAG	3C0413031AJ	ABA4011	VAG	5C0513029B	ABA4001	VAICO	V20-2468	ABA4049
VAG	1T0413031DC	ABA4011	VAG	3C0413031AQ	ABA4011	VAG	5C0513029C	ABA4001	VAICO	V24-0161	ABA4032
VAG	1T0413031DH	ABA4011	VAG	3C0413031AS	ABA4011	VAG	5C0513029D	ABA4001	VAICO	V24-0330	ABA4034
VAG	1T0413031DL	ABA4011	VAG	3C0413031BA	ABA4011	VAG	5C0513029E	ABA4001	VAICO	V24-1710	ABA4015
VAG	1T0413031DM	ABA4011	VAG	3C0413031BB	ABA4011	VAG	5N0413031AE	ABA4011	VAICO	V24-1715	ABA4017
VAG	1T0413031DN	ABA4011	VAG	3C0413031BD	ABA4011	VAG	5N0413031AF	ABA4011	VAICO	V24-1716	ABA4016
VAG	1T0413031DP	ABA4011	VAG	3C0413031M	ABA4011	VAG	5N0413031AQ	ABA4011	VAICO	V25-1869	ABA4005
VAG	1T0413031DQ	ABA4011	VAG	3C0413031N	ABA4011	VAG	5N0413031AR	ABA4011	VITAL S.	200126	ABA4075
VAG	1T0413031DR	ABA4011	VAG	3C0513049AP	ABA4001	VAG	5ND413031B	ABA4011	VITAL S.	200140	ABA4036
VAG	1T0413031DS	ABA4011	VAG	3C0513049AQ	ABA4001	VAG	6C0413031AN	ABA4039	VITAL S.	200255	ABA4022
VAG	1T0413031DT	ABA4011	VAG	3C0513049AR	ABA4001	VAG	6C0413031AP	ABA4039	VITAL S.	200265	ABA4064
VAG	1T0413031EJ	ABA4011	VAG	3C0513049AS	ABA4001	VAG	6C0513025AK	ABA4054	VITAL S.	200577	ABA4072
VAG	1T0413031EL	ABA4011	VAG	3C0513049BD	ABA4001	VAG	6C0513025AL	ABA4054	VITAL S.	200577	ABA4073
VAG	1T0413031EM	ABA4011	VAG	3C0513049BE	ABA4001	VAG	6Q0413031BH	ABA4000	VITAL S.	200688	ABA4075
VAG	1T0413031EQ	ABA4011	VAG	3C0513049BF	ABA4001	VAG	6Q0513025AR	ABA4054	VITAL S.	201274	ABA4023
VAG	1T0413031FF	ABA4011	VAG	3C0513049BG	ABA4001	VAG	6Q0513025BH	ABA4054	VITAL S.	201389	ABA4032
VAG	1T0413031FG	ABA4011	VAG	3C0513049BH	ABA4001	VAG	6Q0513025BJ	ABA4054	VITAL S.	210121	ABA4056
VAG	1T0413031GG	ABA4011	VAG	3C0513049BJ	ABA4001	VAG	6Q0513025P	ABA4054	VITAL S.	210121	ABA4057
VAG	1T0413031GH	ABA4011	VAG	3C0513049BQ	ABA4001	VAG	6Q0513025R	ABA4054	VITAL S.	210126	ABA4075
VAG	1T0413031GK	ABA4011	VAG	3C0513049BR	ABA4001	VAG	6R0413031AJ	ABA4039	VITAL S.	210127	ABA4000
VAG	1T0413031GM	ABA4011	VAG	3C0513049BS	ABA4001	VAG	6R0413031AK	ABA4039	VITAL S.	210127	ABA4075
VAG	1T0413031GN	ABA4011	VAG	3C0513049CE	ABA4001	VAG	6R0413031AL	ABA4039	VITAL S.	210140	ABA4036
VAG	1T0413031GP	ABA4011	VAG	3C0513049CH	ABA4001	VAG	6R0413031AM	ABA4039	VITAL S.	210141	ABA4034
VAG	1T0413031GQ	ABA4011	VAG	3C0513049CJ	ABA4001	VAG	6R0413031AN	ABA4039	VITAL S.	210154	ABA4020
VAG	1T0413031GR	ABA4011	VAG	3C0513049CN	ABA4001	VAG	6R0413031AT	ABA4039	VITAL S.	210154	ABA4021
VAG	1T0413031HB	ABA4011	VAG	3C0513049CP	ABA4001	VAG	6R0413031BB	ABA4039	VITAL S.	210155	ABA4040
VAG	1T0413031HD	ABA4011	VAG	3C0513049CR	ABA4001	VAG	6R0413031BC	ABA4039	VITAL S.	210155	ABA4041
VAG	1T0413031HH	ABA4011	VAG	561413031F	ABA4011	VAG	6R0413031BF	ABA4039	VITAL S.	210156	ABA4018
VAG	1T0413031HJ	ABA4011	VAG	561413031G	ABA4011	VAG	6R0413031C	ABA4039	VITAL S.	210156	ABA4019
VAG	1T0413031HK	ABA4011	VAG	561413031H	ABA4011	VAG	6R0413031Q	ABA4039	VITAL S.	210156	ABA4052
VAG	1T0413031HL	ABA4011	VAG	561413031J	ABA4011	VAG	6R0513025AH	ABA4054	VITAL S.	210156	ABA4053
VAG	1T0413031HM	ABA4011	VAG	561413031K	ABA4011	VAG	6R0513025E	ABA4054	VITAL S.	210159	ABA4064
VAG	1T0413031HN	ABA4011	VAG	561413031L	ABA4011	VAG	6R0513025F	ABA4054	VITAL S.	210163	ABA4070
VAG	1T0413031HP	ABA4011	VAG	561513049B	ABA4001	VAG	6R0513025G	ABA4054	VITAL S.	210166	ABA4072
VAG	1T0413031HQ	ABA4011	VAG	561513049C	ABA4001	VAG	6RU413031B	ABA4039	VITAL S.	210166	ABA4073
VAG	1T0413031HT	ABA4011	VAG	561513049D	ABA4001	VAG	7N0413031J	ABA4011	VITAL S.	210167	ABA4063
VAG	1T0413031JA	ABA4011	VAG	5C0413031AH	ABA4000	VAG	7N0413031K	ABA4011	VITAL S.	210168	ABA4017
VAG	1T0413031JK	ABA4011	VAG	5C0413031AJ	ABA4000	VAG	7N0413031N	ABA4011	VITAL S.	210169	ABA4072
VAG	1T0413031JM	ABA4011	VAG	5C0413031AK	ABA4011	VAG	7N0413031P	ABA4011	VITAL S.	210169	ABA4073
VAG	1T0413031JQ	ABA4011	VAG	5C0413031AL	ABA4011	VAG	7N0413031Q	ABA4011	VITAL S.	210170	ABA4072
VAG	1T0413031JS	ABA4011	VAG	5C0413031AQ	ABA4000	VAG	7N0413031R	ABA4011	VITAL S.	210173	ABA4067
VAG	1T0513029Q	ABA4001	VAG	5C0413031AR	ABA4000	VAG	7N0513049B	ABA4001	VITAL S.	210173	ABA4068
VAG	1T0513029R	ABA4001	VAG	5C0413031AS	ABA4000	VAG	7N0513049K	ABA4001	VITAL S.	210175	ABA4070
VAG	1T0513029S	ABA4001	VAG	5C0413031BA	ABA4011	VAG	7N0513049L	ABA4001	VITAL S.	210176	ABA4058
VAG	3AA413031A	ABA4011	VAG	5C0413031BB	ABA4011	VAG	7N0513049P	ABA4001	VITAL S.	210176	ABA4059
VAG	3AA413031B	ABA4011	VAG	5C0413031BD	ABA4011	VAG	7N0513049Q	ABA4001	VITAL S.	210190	ABA4050
VAG	3AA413031F	ABA4011	VAG	5C0413031BE	ABA4011	VAG	8P0413031	ABA4011	VITAL S.	210190	ABA4051
VAG	3AA413031G	ABA4011	VAG	5C0413031BN	ABA4011	VAG	8Z0513025J	ABA4054	VITAL S.	210223	ABA4012

VITAL S.	210223 ABA4013	VITAL S.	211574 ABA4037	VITAL S.	1112570 ABA4054	VITAL S.	110593.1 ABA4078
VITAL S.	210255 ABA4022	VITAL S.	211590 ABA4037	VITAL S.	1112740 ABA4023	VITAL S.	110593.2 ABA4077
VITAL S.	210337 ABA4025	VITAL S.	211704 ABA4004	VITAL S.	1112800 ABA4035	VITAL S.	110594.1 ABA4078
VITAL S.	210337 ABA4026	VITAL S.	211732 ABA4024	VITAL S.	1112910 ABA4008	VITAL S.	110594.2 ABA4077
VITAL S.	210501 ABA4043	VITAL S.	211737 ABA4024	VITAL S.	1112920 ABA4033	VITAL S.	110688.0 ABA4075
VITAL S.	210501 ABA4076	VITAL S.	211817 ABA4042	VITAL S.	1112940 ABA4004	VITAL S.	110689.0 ABA4039
VITAL S.	210571 ABA4052	VITAL S.	211842 ABA4054	VITAL S.	1113000 ABA4033	VITAL S.	110694.0 ABA4075
VITAL S.	210571 ABA4053	VITAL S.	211843 ABA4054	VITAL S.	1113020 ABA4015	VITAL S.	110775.0 ABA4075
VITAL S.	210577 ABA4072	VITAL S.	211847 ABA4054	VITAL S.	1113080 ABA4004	VITAL S.	110881.0 ABA4064
VITAL S.	210577 ABA4073	VITAL S.	211915 ABA4054	VITAL S.	1113250 ABA4049	VITAL S.	110882.0 ABA4063
VITAL S.	210593 ABA4077	VITAL S.	211916 ABA4001	VITAL S.	1113330 ABA4049	VITAL S.	110886.1 ABA4053
VITAL S.	210593 ABA4078	VITAL S.	211917 ABA4001	VITAL S.	1113340 ABA4049	VITAL S.	110886.2 ABA4052
VITAL S.	210594 ABA4077	VITAL S.	211994 ABA4046	VITAL S.	1113560 ABA4014	VITAL S.	111283.0 ABA4071
VITAL S.	210594 ABA4078	VITAL S.	212012 ABA4069	VITAL S.	1113820 ABA4032	VITAL S.	111293.0 ABA4071
VITAL S.	210598 ABA4029	VITAL S.	212016 ABA4060	VITAL S.	1114470 ABA4005	VITAL S.	111296.0 ABA4065
VITAL S.	210599 ABA4027	VITAL S.	212017 ABA4033	VITAL S.	1115740 ABA4037	VITAL S.	111298.0 ABA4071
VITAL S.	210599 ABA4028	VITAL S.	212060 ABA4047	VITAL S.	1115900 ABA4037	VITAL S.	111301.0 ABA4066
VITAL S.	210655 ABA4038	VITAL S.	1001400 ABA4036	VITAL S.	1117040 ABA4004	VITAL S.	111303.0 ABA4074
VITAL S.	210656 ABA4038	VITAL S.	1002550 ABA4022	VITAL S.	1117320 ABA4024	VITAL S.	111304.0 ABA4074
VITAL S.	210688 ABA4075	VITAL S.	1012740 ABA4023	VITAL S.	1117370 ABA4024	VITAL S.	111305.0 ABA4069
VITAL S.	210689 ABA4039	VITAL S.	1013890 ABA4032	VITAL S.	1118170 ABA4042	VITAL S.	111307.0 ABA4060
VITAL S.	210694 ABA4075	VITAL S.	1101211 ABA4056	VITAL S.	1118420 ABA4054	VITAL S.	111503.0 ABA4071
VITAL S.	210775 ABA4075	VITAL S.	1101212 ABA4057	VITAL S.	1118430 ABA4054	VITAL S.	112012.0 ABA4069
VITAL S.	210776 ABA4011	VITAL S.	1101270 ABA4000	VITAL S.	1118470 ABA4054	VITAL S.	112016.0 ABA4060
VITAL S.	210778 ABA4011	VITAL S.	1101400 ABA4036	VITAL S.	1119150 ABA4054	WKTORY	HG0655 ABA4065
VITAL S.	210873 ABA4003	VITAL S.	1101410 ABA4034	VITAL S.	1119160 ABA4001	WKTORY	HG0672 ABA4066
VITAL S.	210878 ABA4020	VITAL S.	1101541 ABA4020	VITAL S.	1119170 ABA4001	WKTORY	HG0686 ABA4069
VITAL S.	210878 ABA4021	VITAL S.	1101542 ABA4021	VITAL S.	1119940 ABA4046	WKTORY	HG5314 ABA4069
VITAL S.	210881 ABA4064	VITAL S.	1101551 ABA4041	VITAL S.	1120170 ABA4033	WKTORY	M 3715 ABA4075
VITAL S.	210882 ABA4063	VITAL S.	1101552 ABA4040	VITAL S.	1120600 ABA4047	WKTORY	M0608 ABA4036
VITAL S.	210886 ABA4018	VITAL S.	1101561 ABA4018	VITAL S.	100126.0 ABA4075	WKTORY	M1333 ABA4022
VITAL S.	210886 ABA4019	VITAL S.	1101562 ABA4019	VITAL S.	100265.0 ABA4064	WKTORY	MG0165 ABA4056
VITAL S.	210886 ABA4052	VITAL S.	1101681 ABA4016	VITAL S.	100577.1 ABA4072	WKTORY	MG0165 ABA4057
VITAL S.	210886 ABA4053	VITAL S.	1101682 ABA4017	VITAL S.	100577.2 ABA4073	WKTORY	MG0166 ABA4056
VITAL S.	211245 ABA4055	VITAL S.	1101901 ABA4050	VITAL S.	100688.0 ABA4075	WKTORY	MG0166 ABA4057
VITAL S.	211257 ABA4054	VITAL S.	1101902 ABA4051	VITAL S.	110126.0 ABA4075	WKTORY	MG0330 ABA4075
VITAL S.	211274 ABA4023	VITAL S.	1102231 ABA4012	VITAL S.	110127.0 ABA4075	WKTORY	MG0343 ABA4000
VITAL S.	211280 ABA4035	VITAL S.	1102232 ABA4013	VITAL S.	110154.2 ABA4040	WKTORY	MG0608 ABA4036
VITAL S.	211283 ABA4071	VITAL S.	1102550 ABA4022	VITAL S.	110156.1 ABA4053	WKTORY	MG0609 ABA4034
VITAL S.	211291 ABA4008	VITAL S.	1103371 ABA4026	VITAL S.	110156.2 ABA4052	WKTORY	MG0639 ABA4020
VITAL S.	211292 ABA4033	VITAL S.	1103372 ABA4025	VITAL S.	110159.0 ABA4064	WKTORY	MG0639 ABA4021
VITAL S.	211293 ABA4071	VITAL S.	1105010 ABA4043	VITAL S.	110163.0 ABA4070	WKTORY	MG0639 ABA4040
VITAL S.	211294 ABA4004	VITAL S.	1105711 ABA4003	VITAL S.	110166.1 ABA4072	WKTORY	MG0640 ABA4020
VITAL S.	211296 ABA4065	VITAL S.	1105712 ABA4052	VITAL S.	110166.2 ABA4073	WKTORY	MG0640 ABA4021
VITAL S.	211298 ABA4071	VITAL S.	1105982 ABA4029	VITAL S.	110167.0 ABA4063	WKTORY	MG0640 ABA4040
VITAL S.	211300 ABA4033	VITAL S.	1105991 ABA4028	VITAL S.	110169.1 ABA4072	WKTORY	MG0641 ABA4041
VITAL S.	211301 ABA4066	VITAL S.	1105992 ABA4027	VITAL S.	110169.2 ABA4073	WKTORY	MG0642 ABA4040
VITAL S.	211302 ABA4015	VITAL S.	1106550 ABA4038	VITAL S.	110170.1 ABA4072	WKTORY	MG0642 ABA4041
VITAL S.	211303 ABA4074	VITAL S.	1106560 ABA4038	VITAL S.	110170.2 ABA4073	WKTORY	MG0646 ABA4019
VITAL S.	211304 ABA4074	VITAL S.	1106890 ABA4039	VITAL S.	110173.1 ABA4068	WKTORY	MG0646 ABA4052
VITAL S.	211305 ABA4069	VITAL S.	1107760 ABA4011	VITAL S.	110173.2 ABA4067	WKTORY	MG0646 ABA4053
VITAL S.	211307 ABA4060	VITAL S.	1107780 ABA4011	VITAL S.	110175.0 ABA4070	WKTORY	MG0647 ABA4018
VITAL S.	211308 ABA4004	VITAL S.	1108731 ABA4003	VITAL S.	110176.1 ABA4059	WKTORY	MG0647 ABA4052
VITAL S.	211334 ABA4049	VITAL S.	1108781 ABA4020	VITAL S.	110176.2 ABA4058	WKTORY	MG0647 ABA4053
VITAL S.	211356 ABA4014	VITAL S.	1108782 ABA4021	VITAL S.	110501.0 ABA4076	WKTORY	MG0654 ABA4064
VITAL S.	211382 ABA4032	VITAL S.	1108861 ABA4018	VITAL S.	110571.1 ABA4053	WKTORY	MG0660 ABA4070
VITAL S.	211447 ABA4005	VITAL S.	1108862 ABA4019	VITAL S.	110577.1 ABA4072	WKTORY	MG0668 ABA4073
VITAL S.	211503 ABA4071	VITAL S.	1112450 ABA4055	VITAL S.	110577.2 ABA4073	WKTORY	MG0669 ABA4073

WKTORY	MG0670 ABA4063	WKTORY	TG0507 ABA4023	WROOM	WRS55061 ABA4035
WKTORY	MG0673 ABA4016	WKTORY	TG0610 ABA4035	WROOM	WRS55064 ABA4071
WKTORY	MG0674 ABA4017	WKTORY	TG0618 ABA4071	WROOM	WRS55067 ABA4008
WKTORY	MG0676 ABA4072	WKTORY	TG0643 ABA4008	WROOM	WRS55069 ABA4004
WKTORY	MG0677 ABA4073	WKTORY	TG0644 ABA4033	WROOM	WRS55070 ABA4015
WKTORY	MG0679 ABA4072	WKTORY	TG0648 ABA4004	WROOM	WRS55075 ABA4001
WKTORY	MG0680 ABA4073	WKTORY	TG0662 ABA4071	WROOM	WRS55077 ABA4033
WKTORY	MG0684 ABA4067	WKTORY	TG0667 ABA4033	WROOM	WRS55079 ABA4069
WKTORY	MG0685 ABA4068	WKTORY	TG0675 ABA4015	WROOM	WRS55083 ABA4037
WKTORY	MG0691 ABA4059	WKTORY	TG0678 ABA4074	WROOM	WRS55088 ABA4063
WKTORY	MG0692 ABA4058	WKTORY	TG0681 ABA4074	WROOM	WRS55089 ABA4048
WKTORY	MG0863 ABA4050	WKTORY	TG0693 ABA4060	WROOM	WRS55092 ABA4064
WKTORY	MG0863 ABA4051	WKTORY	TG0865 ABA4049	WROOM	WRS55093 ABA4070
WKTORY	MG0864 ABA4050	WKTORY	TG0889 ABA4049	WROOM	WRS55094 ABA4067
WKTORY	MG0981 ABA4012	WKTORY	TG0892 ABA4049	WROOM	WRS55095 ABA4068
WKTORY	MG0981 ABA4013	WKTORY	TG0983 ABA4014	WROOM	WRS55097 ABA4026
WKTORY	MG0982 ABA4012	WKTORY	TG1318 ABA4032	WROOM	WRS55098 ABA4025
WKTORY	MG0982 ABA4013	WKTORY	TG1538 ABA4005	WROOM	WRS55100 ABA4076
WKTORY	MG1333 ABA4022	WKTORY	TG2244 ABA4071	WROOM	WRS55103 ABA4013
WKTORY	MG1536 ABA4025	WKTORY	TG2558 ABA4037	WROOM	WRS55104 ABA4012
WKTORY	MG1537 ABA4026	WKTORY	TG2591 ABA4037	WROOM	WRS55133 ABA4058
WKTORY	MG2557 ABA4043	WKTORY	TG2989 ABA4004	WROOM	WRS55134 ABA4059
WKTORY	MG2557 ABA4076	WKTORY	TG3081 ABA4024	WROOM	WRS55136 ABA4032
WKTORY	MG2987 ABA4003	WKTORY	TG3099 ABA4024	WROOM	WRS55150 ABA4054
WKTORY	MG2987 ABA4052	WKTORY	TG3467 ABA4042	WROOM	WRS55159 ABA4014
WKTORY	MG2987 ABA4053	WKTORY	TG3716 ABA4054	WROOM	WRS55161 ABA4046
WKTORY	MG2988 ABA4052	WKTORY	TG3720 ABA4054	WROOM	WRS55165 ABA4055
WKTORY	MG2988 ABA4053	WKTORY	TG3811 ABA4054	WROOM	WRS55170 ABA4042
WKTORY	MG3079 ABA4078	WKTORY	TG4451 ABA4054	WROOM	WRS55174 ABA4060
WKTORY	MG3080 ABA4077	WKTORY	TG4456 ABA4001	WROOM	WRS55178 ABA4047
WKTORY	MG3102 ABA4029	WKTORY	TG4459 ABA4001	WROOM	WRS55181 ABA4005
WKTORY	MG3104 ABA4027	WKTORY	TG5325 ABA4060	WROOM	WRS55185 ABA4022
WKTORY	MG3105 ABA4028	WKTORY	TG5326 ABA4033	WROOM	WRS55209 ABA4051
WKTORY	MG3466 ABA4038	WKTORY	TG6009 ABA4047	WROOM	WRS55210 ABA4050
WKTORY	MG3468 ABA4038	WKTORY	VMG0864 ABA4051	WROOM	WRS55224 ABA4057
WKTORY	MG3715 ABA4075	WROOM	WRS55011 ABA4038	WROOM	WRS55225 ABA4056
WKTORY	MG3719 ABA4039	WROOM	WRS55015 ABA4009	WROOM	WRS55234 ABA4027
WKTORY	MG3810 ABA4075	WROOM	WRS55015 ABA4021	WROOM	WRS55235 ABA4028
WKTORY	MG4452 ABA4075	WROOM	WRS55016 ABA4010	WROOM	WRS55244 ABA4049
WKTORY	MG4455 ABA4011	WROOM	WRS55016 ABA4020	WROOM	WRS55274 ABA4045
WKTORY	MG4458 ABA4011	WROOM	WRS55017 ABA4017	WROOM	WRS55275 ABA4044
WKTORY	MG5217 ABA4003	WROOM	WRS55018 ABA4016	WROOM	WRS55276 ABA4030
WKTORY	MG5302 ABA4020	WROOM	WRS55021 ABA4036	WROOM	WRS55277 ABA4029
WKTORY	MG5302 ABA4021	WROOM	WRS55032 ABA4000	WROOM	WRS55278 ABA4024
WKTORY	MG5303 ABA4020	WROOM	WRS55033 ABA4075	WROOM	WRS55331 ABA4066
WKTORY	MG5303 ABA4021	WROOM	WRS55039 ABA4034	WROOM	WRS55345 ABA4072
WKTORY	MG5309 ABA4064	WROOM	WRS55040 ABA4011	WROOM	WRS55346 ABA4073
WKTORY	MG5310 ABA4063	WROOM	WRS55044 ABA4002		
WKTORY	MG5322 ABA4019	WROOM	WRS55044 ABA4019		
WKTORY	MG5322 ABA4052	WROOM	WRS55044 ABA4052		
WKTORY	MG5322 ABA4053	WROOM	WRS55045 ABA4003		
WKTORY	MG5323 ABA4018	WROOM	WRS55045 ABA4018		
WKTORY	MG5323 ABA4052	WROOM	WRS55045 ABA4053		
WKTORY	MG5323 ABA4053	WROOM	WRS55049 ABA4040		
WKTORY	T0507 ABA4023	WROOM	WRS55050 ABA4041		
WKTORY	T1326 ABA4032	WROOM	WRS55051 ABA4039		
WKTORY	TG0167 ABA4055	WROOM	WRS55052 ABA4043		
WKTORY	TG0331 ABA4054	WROOM	WRS55054 ABA4023		



A doppio tubo	Twin tube	Bi-tubes
A pressione del gas	Gas type	à gaz
Ammortizzatore	Shock-absorber	Amortisseur
Anteriore	Front	Avant
Applicazioni	Applications	Affectation
Collare	Clamp	Clamp
Diametro Corpo	Body diameter	Diamètre du corps
Diametro Stelo	Stem diameter	Diamètre de la tige
Fissaggio Inferiore	Lower fixing	Fixation inférieure
Fissaggio Superiore	Upper fixing	Fixation supérieure
Interasse Boccole	Distance between bushings	Distance entre les douilles
Note	Note	Note
Occhiello	Eye	Bossage
Parapolvere	Dust cover	Soufflet
Posizione	Position	Position
Posteriore	Rear	Arriere
Sistema	System	Système
Spina	Pin	Goujon
Staffa	Bracket	Collier
Supporto	Strut mount	Coupelle d'amortisseur
Tampone	Dumper	Butées de suspension
Tipologia	Type	Type
Zona di montaggio	Fitting position	Zone de montage



www.abparts.it



info@abparts.it

